

CITIZEN

MOBILE THERMAL PRINTER

MODEL CMP-30II series

User's Manual



CITIZEN SYSTEMS JAPAN CO., LTD.

WEEE MARK

- En** If you want to dispose of this product, do not mix it with general household waste. There is a separate collection systems for used electronics products in accordance with legislation under the WEEE Directive (Directive 2002/96/EC) and is effective only within European Union.
- Ge** Wenn Sie dieses Produkt entsorgen wollen, dann tun Sie dies bitte nicht zusammen mit dem Haushaltsmüll. Es gibt im Rahmen der WEEE-Direktive innerhalb der Europäischen Union (Direktive 2002/96/EC) gesetzliche Bestimmungen für separate Sammelsysteme für gebrauchte elektronische Geräte und Produkte.
- Fr** Si vous souhaitez vous débarrasser de cet appareil, ne le mettez pas à la poubelle avec vos ordures ménagères. Il existe un système de récupération distinct pour les vieux appareils électroniques conformément à la législation WEEE sur le recyclage des déchets des équipements électriques et électroniques (Directive 2002/96/EC) qui est uniquement valable dans les pays de l'Union européenne.
Les appareils et les machines électriques et électroniques contiennent souvent des matières dangereuses pour l'homme et l'environnement si vous les utilisez et vous vous en débarrassez de façon inappropriée.
- Sp** Si desea deshacerse de este producto, no lo mezcle con residuos domésticos de carácter general. Existe un sistema de recogida selectiva de aparatos electrónicos usados, según establece la legislación prevista por la Directiva 2002/96/CE sobre residuos de aparatos eléctricos y electrónicos (RAEE), vigente únicamente en la Unión Europea.
- It** Se desiderate gettare via questo prodotto, non mescolatelo ai rifiuti generici di casa. Esiste un sistema di raccolta separato per i prodotti elettronici usati in conformità alla legislazione RAEE (Direttiva 2002/96/CE), valida solo all'interno dell'Unione Europea.
- Du** Deponer dit product niet bij het gewone huishoudelijk afval wanneer u het wilt verwijderen. Er bestaat ingevolge de WEEE-richtlijn (Richtlijn 2002/96/EG) een speciaal wettelijk voorgeschreven verzamelstelsel voor gebruikte elektronische producten, welk alleen geldt binnen de Europese Unie.
- Da** Hvis du vil skille dig af med dette produkt, må du ikke smide det ud sammen med dit almindelige husholdningsaffald. Der findes et separat indsamlingssystem for udtjente elektroniske produkter i overensstemmelse med lovgivningen under WEEE-direktivet (direktiv 2002/96/EC), som kun er gældende i den Europæiske Union.
- Por** Se quiser deitar fora este produto, não o misture com o lixo comum. De acordo com a legislação que decorre da Directiva REEE – Resíduos de Equipamentos Eléctricos e Electrónicos (2002/96/CE), existe um sistema de recolha separado para os equipamentos electrónicos fora de uso, em vigor apenas na União Europeia.
- Pol** Jeżeli zamierzasz pozbyć się tego produktu, nie wyrzucaj go razem ze zwykłymi domowymi odpadkami. Według dyrektywy WEEE (Dyrektywa 2002/96/EC) obowiązującej w Unii Europejskiej dla używanych produktów elektronicznych należy stosować oddzielne sposoby utylizacji.



Declaration of Conformity

This printer conforms to the following Standards:

The Low Voltage Directive 2014/35/EU, the EMC Directive 2014/30/EC, the R&TTE Directive 1999/5/EC (till 2017/6/12), the RE Directive 2014/53/EU (on/ after 2017/6/13) and the RoHS Directive 2002/95/EC.

LVD : EN60950-1	R&TTE/RE: EN300 328
EMC: EN55032 Class B	EN301 489-1
EN55024	EN301 489-17
EN 61000-3-2	EN301 893
EN 61000-3-3	EN300 440-1
	EN300 440-2



FCC Compliance Statement for American Users

This equipment has been tested and found to comply with the limits for a Class B digital device, pursuant to Part 15 of the FCC Rules. These limits are designed to provide reasonable protection against harmful interference in a residential installation. This equipment generates, uses, and can radiate radio frequency energy and, if not installed and used in accordance with the instructions, may cause harmful interference to radio communications. However, there is no guarantee that interference will not occur in a particular installation. If this equipment does cause interference to radio or television reception, which can be determined by turning the equipment off and on, the user is encouraged to try to correct the interference by one or more of the following measures:

- Reorient or relocate the receiving antenna.
- Increase the separation between the equipment and receiver.
- Connect the equipment into an outlet on a circuit different from that to which receiver is connected.
- Consult the dealer or an experienced radio/TV technician for help.

CAUTION: Use shielded cables to connect this device to computers.

Any changes or modifications not expressly approved by the grantee of this device could void the user's authority to operate the equipment.

EMI Compliance Statement for Canadian Users

- This Class B digital apparatus complies with Canadian ICES-003.
- Cet appareil numérique de la classe B est conforme à la norme NMB-003 du Canada.

GENERAL PRECAUTIONS



- Before using this product, be sure to read through this manual. After having read this manual, keep it in a safe, readily accessible place for future reference.
- The information contained herein is subject to change without prior notice.
- Reproduction or transfer of part or all of this document in any means is prohibited without permission from CITIZEN SYSTEMS.
- Note that CITIZEN SYSTEMS is not responsible for any operation results regardless of missing, error, or misprinting in this manual.
- Note that CITIZEN SYSTEMS is not responsible for any trouble caused as a result of using options or consumables that are not specified in this manual.
- Except explained elsewhere in this manual, do not attempt to service, disassemble or repair this product.
- Note that CITIZEN SYSTEMS is not responsible for any damage attributable to incorrect operation/handling or improper operating environments which are not specified in this manual.
- Due to the nature of thermal paper, printed data should be considered for temporary use, not stored for a long period or permanently. Please note that CITIZEN SYSTEMS is not responsible for damage or lost profit resulting from the loss of data caused by accidents, repairs, tests or other occurrence.
- If you find loss of information, error, or uncertain matter, please contact your CITIZEN SYSTEMS dealer.
- If you find any disordered or missing page (s), contact you CITIZEN SYSTEMS dealer for replacement.

- iPad, iPhone, iPod, iPod touch, and Mac OS are trademarks of Apple Inc., registered in the U.S. and other countries.
- “Made for iPod,” “Made for iPhone,” and “Made for iPad” mean that an electronic accessory has been designed to connect specifically to iPod, iPhone, or iPad, respectively, and has been certified by the developer to meet Apple performance standards. Apple is not responsible for the operation of this device or its compliance with safety and regulatory standards. Please note that the use of this accessory with iPod, iPhone or iPad may affect wireless performance.
- Lithium Button Cell is equipped on the PCB(Printed Circuit Board). When disposal, the proper separation for Lithium Button Cell is needed.
- ESC/POS is a registered trademark of Seiko Epson Corporation.
- iPad, iPhone, iPod, iPod touch, and Mac OS are trademarks of Apple Inc., registered in the U.S. and other countries.
- Bluetooth is a registered trademark of Bluetooth SIG, Inc.
- Windows is a trade mark of Microsoft Corporation in the United States and/or other countries.
- Android is a registered trademark of Google Inc.
- Company names and product names in this manual are trademarks or registered trademarks of relevant companies.
- CITIZEN is a registered trademark of Citizen Watch Co., Japan
- Copyright © 2016 by CITIZEN SYSTEMS JAPAN CO., LTD.

SAFETY PRECAUTIONS

What the Icons Mean

Precautions and notices necessary to follow for preventing hazards to the user or other person or their properties are defined as shown below. Hazards and degrees of damage that may be caused by ignoring the instructions are categorized as shown below. Please be familiar with the content of these definitions before reading this manual.

 DANGER	Indicates the case that may result in death or serious injury.
 WARNING	This symbol indicates that using the product improperly in defiance of this symbol may result in death or serious injury.
 CAUTION	This symbol indicates that using the product improperly in defiance of this symbol may result in injury or damage to properties.

Definition of the icons



This symbol indicates the hazard that needs precautions.



This symbol indicates prohibited actions.



This symbol indicates mandatory actions.

Precautions in Handling Printer



WARNING



- If the product continues to be used when heat or smoke is generated or an abnormal odor is produced, a fire may occur. Immediately turn the printer power off, and carefully but quickly remove the battery, then contact our service agent.
- If any foreign matter (metal tip, water, liquid) enters the product, immediately turn the printer power OFF, and carefully but quickly remove the battery, then contact our service agent. Ignoring this instruction may result in a fire.



CAUTION



- This equipment is not suitable for use in locations where children are likely to be present.
- Do not place the printer on a shaky table or other unbalanced place. The printer may drop or fall resulting in injury.
- Avoid using or storing in the following place. Damage to printer may be caused.
 - In a car parked in a sunny place, a place exposed to direct sunlight, near heat generating equipment, or the like.
 - A place where temperature or humidity is excessively high or low, or its change is radical.
 - A dusty place.
 - A place likely to get a splash of water or liquid.
- Avoid dropping, impacting or vibrating the printer otherwise damage may be caused.
- Avoid entry of foreign material. Otherwise, fault may occur.
- Do not use volatile liquid (thinner, benzene, etc.) or wet cloth when cleaning the printer. Deterioration or discoloration may occur. Use a dry, soft cloth for cleaning.
- Do not move the printer or give any shock or vibration to it while the printer is in operation or in standby operation. The printer power may be disconnected and the print data may be lost.

Precautions on Using Printer



WARNING



- Do not touch the print head or paper cutter while replacing print paper. Heated print head may cause burn. The cutter may cause injury to the hand.



CAUTION



- Use of print paper other than specified may result in not only deteriorated print quality but shortened life of print head (printing portion).
- Do not tap or rub the print head with edged or hard material.
- When condensation is present on the print head, dry it completely before printing. Printing with condensation may damage the print head.



Precaution on Overheating



CAUTION



- To prevent the motor from overheating, continuous printing (or feeding) of the printer should be 1.5 m or less in print length. After printing for this distance we recommend a pause of at least 30 seconds for cooling.

Precautions on Using Battery



DANGER



- Leaked liquid from the battery may result in loss of eyesight if it enters the eye. Immediately wash eyes with fresh water and get medical care.
- If liquid from the battery is ingested, immediately seek medical attention.
- Keep the following in mind when handling battery. Otherwise, liquid leakage, heat generation, and explosion may result.
 - Do not throw battery into fire or do not apply heat.
 - Do not peel or scratch the external battery casing.
 - Soldering is prohibited.
 - Do not give strong shock to battery or throw it away.
 - Do not short-circuit the positive and negative terminals with a metal such as metal wire.
- Never disassemble or modify battery. Otherwise, liquid leakage, heat generation, or explosion may occur.



WARNING



- If battery liquid attaches to skin or cloth, immediately wash it out with fresh water. Otherwise, skin disorder may be caused.



CAUTION



- Risk of explosion if battery is replaced by an incorrect type.
- Dispose of used batteries according to the instructions.
- Use only the approved external charger or charge the battery within the printer.
- Never use another charger or one that looks to be similar.



CAUTION



- Do not dip battery in water or sea water. Wet battery may generate heat or may be subject to corrosion.
- Do not use or leave battery at high temperature. Using or leaving battery in a place of high temperature may result in liquid leakage, deteriorated performance, or shortened lifetime.



- Keep battery beyond the reach of a baby or child. Pay attention not to let a child take out the battery.
- If the battery is used for the first time, be sure to charge it completely before use.
- If any abnormality is found while the battery is in use, stop the operation and carry the battery in local sales agent.
- The battery in the printer is shipped partially charged. Please fully charge the battery prior to using the printer.

Precautions on Installing New Paper



CAUTION



- Before printing, confirm that print paper is set straight forward at the exit from the print (thermal) head. Skewed setting may result in paper jamming.
- To prevent skewed insertion of paper, use the following form for the end of paper.

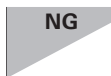
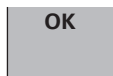

Precautions on Using Thermal Paper



CAUTION



- Print density may change with different kind of paper and atmosphere temperature.
- Observe the following when using thermal paper. Thermal paper is not resistant to discoloration, deterioration in quality, and thin printing.
 - Do not leave printed thermal paper exposed to light for a long time.
 - Avoid exposure to high temperature, humidity, liquid, or sunlight.
 - When keeping the printer thermal paper on a board, do not use paste, adhesive, or adhesive tape containing volatile organic solvent.
 - For long-time storage, use thermal paper of high storage type or copy it with plain paper copier.
 - Avoid contact with a film of vinyl chloride for a long time.
 - Avoid using ammonia. Do not put thermal paper near the paper copied by use of ammonia.
 - Avoid putting sweat or grease from your hands on the surface (printed or to be printed) of thermal paper.
 - Store thermal paper in a dark place with average temperature below 25°C and relative humidity below 65% .
- Using print paper with a thickness outside the recommended range may cause improper print quality.

Precautions on Using Special Serial Cable



WARNING



- With one side of the connector connected to this product, do not touch the metal part of the other connector.



CAUTION



- Static electricity may cause breakdown of internal circuit of this product.
- Do not leave this product with a cable wound around it for a long time. Disconnection or discoloration may result.
- Plugging and unplugging the contactor shall be done securely in the correct direction.

Precautions on Using Charger



CAUTION



- Do not use the product at a voltage and frequency other than specified.
- Do not use Charger other than specified.
- Before use, confirm that the power receptacle has sufficient capacity.
- Do not connect to the power receptacle where multiple connections are used.
- Do not step on, tap, or put any object, on the cable of the Charger.
- Before connecting or disconnecting Charger, turn the printer power OFF. Do the operation securely.

THE TABLE OF CONTENTS

1. GENERAL OUTLINE	14
1.1 Features.....	14
1.2 Unpacking	15
1.3 Model Classifications	17
1.4 Basic Specifications	18
2. EXPLANATION OF PRINTER PARTS.....	20
2.1 Printer Appearance	20
2.2 Operation Panel	22
3. OPERATION	24
3.1 Setting/Replacing the paper roll	24
3.2 Installing Belt Clip.....	25
3.3 How to secure partition for 58mm	25
3.4 Installing & Using Battery	26
3.5 Charging the Battery	27
3.6 Removing Battery (with Belt Clip).....	28
3.7 Wireless Communication	29
3.8 Interface Cable Connection	32
3.9 Self Test	33
3.10 Optimizing the Media Detection Level (Sensor Calibration)	34
3.11 Power Save Mode, Auto Power Off.....	35
4. Utility, Drivers and SDK	36
4.1 Utility.....	36
4.2 Printing via Driver or SDK.....	37
5. Media specifications	38
5.1 Roll paper	38

5.2 Label	39
5.3 Black mark	40

1. GENERAL OUTLINE

CMP-30II is a compact, full featured portable line thermal printer, which can be used in a large variety of job environments.

Bluetooth/WiFi communication with a PDA or similar device is useful for business activities at the point of sale or service.

1.1 Features

- Compact and Robust
- High speed and low noise emission of the line thermal printing
- Long-life printing head with high reliability
- Easy paper-handling, owing to the paper-drop-in style
- Lithium-ion rechargeable battery
- 3 LED to indicate battery status
- Equipped with USB and serial port as standard
- Built-in Bluetooth 4.2 (CMP-30IIBT)
- Built-in 2.4 / 5.0 GHz Wi-Fi (CMP-30IIWF)
- Auto power save, Auto power off mode
- Emulation of CPCL & ESC / POS or ZPL2
- Fitted with a label sensor and black-mark sensor
- Automatic response to Bluetooth for iOS devices and other devices (CMP-30IIBT)
- SoftAP function enables Wi-Fi communication without Access Point. (CMP-30IIWF)
- Linked with host power-on via USB connection

1.2 Unpacking

Standard



Printer

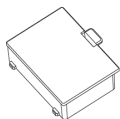

Battery
(CMP-BA30)

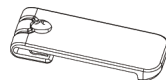

Belt Clip



Charger
(CMP-AD21US)

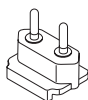

EC Plug
(CMP-21EPLUG)

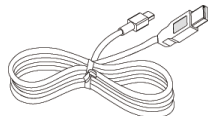

USB Cable
(CA20-U01)



Paper Roll

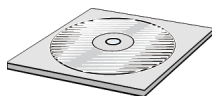

CD-ROM

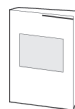

Quick Start Guide

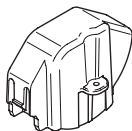

Partition for 58mm

Option



Battery Cradle
(CMP-BC30)



Car Charger
(CMP-CC21)

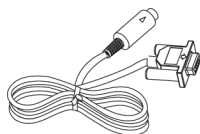

Serial Cable
(CA20-S01)

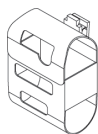

Leather Case
(SC30-01)



Strap
(STP20-01)

1.3 Model Classifications

Classified by the following designation.

CMP-30IIBT U C L

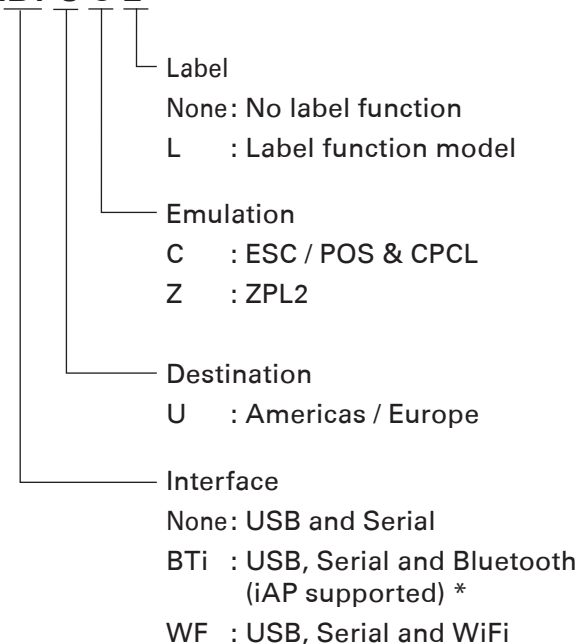

* iAP is necessary to connect to Apple iOS device.



NOTE

There is no products available for some of the combination.

1.4 Basic Specifications

Printing Method		DirectThermal
Printing Speed		100 mm / sec
Print Width		Max. 72 mm (576 dots)
Resolution		203 DPI x 203 DPI
Character	ESC/POS	FontA(12x24), FontB(9x17), Asian Font(KOR, JPN,CHN_GB2312,CHN_BIG5), Codepages x 24, International Characters x14
	CPCL	Resident Font Type 0/1/2/4/5/6/7, Size 0-7 Asian Font (24 x 24) Resident TTF, Downloadable TTF
	ZPL	FontA~H, FontGS,Resident TTF(Font0), Downloadable TTF
Barcode	ESC/POS	1D: EAN-8, EAN-13, Code39, ITF, UPC-A, UPC-E, Codabar, Code93, Code128 2D: QR, PDF417
	CPCL	1D: LUPC-A(+2,+5), UPC-E(+2, +5), EAN13(+2, +5), EAN8(+2,+5), Code39 etc. (CPCL) 2D: QR, PDF417, MicroPDF417, Maxicode, Datamatrix, Aztec, TLC39, RSS14
	ZPL	1D : Code11, ITF, Code39, Planet, EAN-8, UPC-E, Code93, Code128 etc. (ZPLII) 2D: QR, PDF417, MicroPDF417, Maxicode, Datamatrix, Aztec, TLC39, RSS14
Emulation		ESC/POS, CPCL, ZPLII Command Compatible
Input buffer size		8K bytes (USB), 32K bytes (Others)
Sensor		Paper End, Cover Open, Reflective Sensor x 2 (Upper / Lower)
Paper	Paper type	Thermal Paper
	Width	25.5 +/- 0.5 mm ~ 79.5 +/- 0.5 mm
	Thickness	0.06 mm ~ 0.16 mm
	External Diameter	Max. Ø 56 mm
	Core Diameter	12.5 mm +/- 0.5 mm

Reliability	Thermal Printer Head	50 km or 100,000,000 pulses
	Battery	Continuous Printing 60 min (250 m) Standby for 48 hours
	Drop	1.5 m (Company Standard)
	Environmental Sealing	IP 42
Communications	Standard	Serial(RS-232C), USB
	Optional	Bluetooth V 4.2 Class2 or Wi-Fi (802.11 a/b/g)
Battery Charger	Input	AC 100 ~ 240 V, 50 / 60 Hz
	Output	8.4 V , 800 ~ 1400 mA
Battery	Battery Type	Li-ion
	Output	7.4 V 2600 mAh
	Charging Time	180 min
Size W x D x H(mm)		120(W) x 152 (D) x 70(H) mm
Weight		530 g (Without Battery), 640 g (With Battery)
Temperature	Operation	-10 to +50 °C ^{*1}
	Storage	-20 to +60 °C
Humidity	Operation	30 to 80 %
	Storage	10 to 85 %
Safety standrd. EMC		UL, FCC Class B, CE Mark

*1 This does not guarantee printing quality at low temperature.

2. EXPLANATION OF PRINTER PARTS

2.1 Printer Appearance

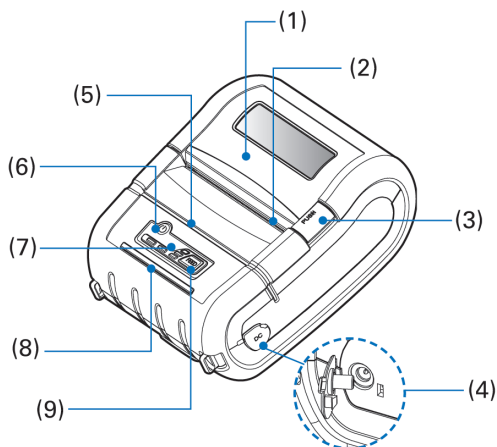

- (1) Paper Cover
Set paper roll inside this cover.
- (2) Manual Cutter (Tear Bar)
To cut the printed paper, gently pull the paper from the edge of the paper at the angle so that paper firmly contacts the serrated cutter.
- (3) Paper Cover Open Button (blue colour)
Press down to open the paper cover for replacing the paper roll.
- (4) DC jack
Connect Charger for recharging battery.
- (5) MSR Slot (Optional*)
*This function is not available.
- (6) Power Button
Press and hold the Power button for approximately 3 seconds to turn the printer power ON.
To turn OFF the printer, press and hold the Power button until the Power LED gets off.



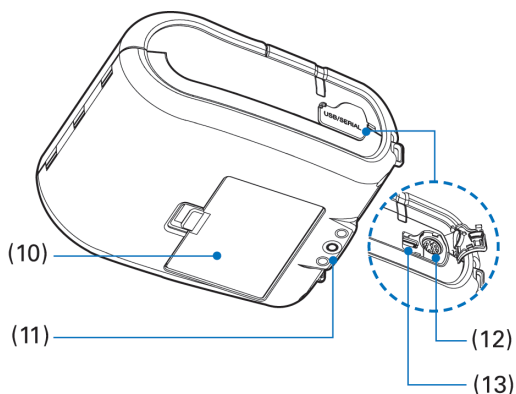

- (7) Control Panel
Refer to section 2.2 Operation Panel.
- (8) IC Card Slot (Optional*)
*This function is not available.
- (9) Paper Feed Button
Press once for 1 line paper feed.
Press down and hold for continuous paper feed to any required length.

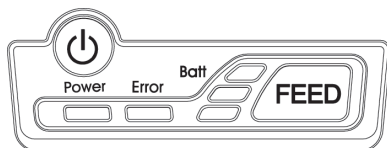

- (10) Battery
Refer to section 3.4 Installing & Using Battery to 3.6 Removing Battery (with Belt Clip).
- (11) Belt Clip Hole
Refer to section 3.2 Installing Belt Clip.
- (12) Serial port
For serial cable connection to host.
- (13) USB Port (Mini B connector)
For USB cable connection to host.

2.2 Operation Panel



Button/LED	Name	Function
	Power Button and Power LED	<p>When the printer is off, press this button for approximately 3 seconds and it will turn on the power. When on, pressing the button will switch off the printer.</p> <p>The power of the printer will turn on when the power of a host connected via USB is turned on.</p> <p>The "Power" LED lights when the power turns on and flashes slowly when a Bluetooth or wireless LAN connection is established. If SoftAp is selected, Power LED always blinks. It flashes quickly while data is being received via Bluetooth or wireless LAN.</p>
	Paper Feed Button	<p>Paper can be fed manually by pressing this button.</p> <p>Additionally, a self-test can be produced - refer to "3.9" for self test information.</p>
	Battery Status LED	<ol style="list-style-type: none"> 1. If all three of the "Batt" LEDs are lit, the battery is fully charged. 2. If you can hear beeping sound and all lights are turned off, it means that the battery is at the lowest level. 3. If the battery is not charged at all, the printer turns off automatically.
	Error LED	<p>If the red light is turned on, it means no paper, paper cover open or media detection error.</p>

 **NOTE**

1. The battery status LEDs give an indication of power remaining. Actual run-time remaining will depend on many factors such as the contents of the output, distance to the computer, etc.
2. When the battery level is very low, high density printing can result in the printer switching off during printing resulting in possible loss of data.

3. OPERATION

3.1 Setting/Replacing the paper roll

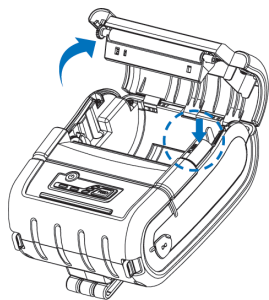

- (1) Press the Blue Paper Cover Open button and lift the paper cover.

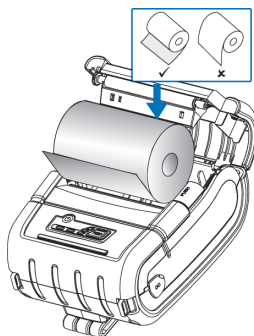

- (2) Place the paper roll as shown. Make sure the paper is placed in right direction.



NOTE

Do not use 2 inch paper.

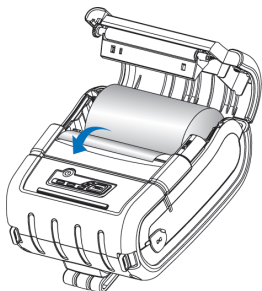

- (3) Pull a short length of paper out of the printer and then press center of the paper cover to close the cover.

3.2 Installing Belt Clip

- (1) Insert screw into belt clip.
- (2) Tighten the screw with driver as shown.

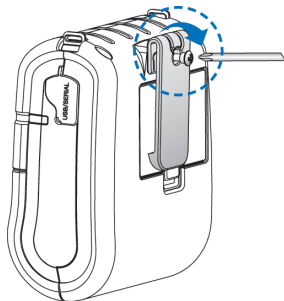
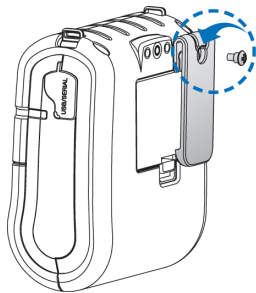

NOTE

The belt clip is included in the pack as a standard item but does not need to be used or installed!

3.3 How to secure partition for 58mm

- (1) Move the movable partition to the left.
- (2) Place the partition for 58mm so that the mounting hole for the partition for 58mm aligns with the screw hole positioned on the top of the case.
- (3) Secure the partition for 58mm with a screw and align the movable partition to the right.

3.4 Installing & Using Battery

- (1) Align battery hook as shown in the picture.
- (2) Push the battery into the printer until it locks in place.
- (3) To release or remove the battery, gently pull the release catch towards the battery module and rotate the battery from the printer.

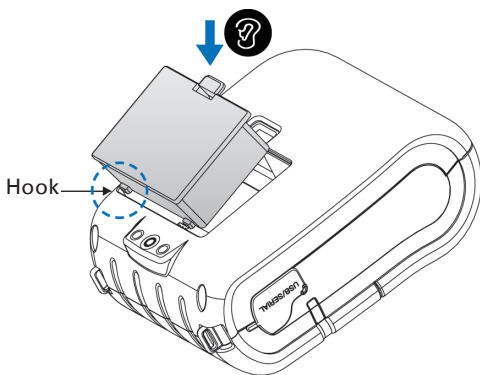

NOTE

1. As the battery is not charged at the time of your purchase, charge the battery fully prior to using the printer.
(Batteries can be charged in the printer or optional external cradle.)
2. When used in low temperatures, the battery's operation time may decrease.
3. The full charge level for the battery will decrease with each discharge, gradually decreasing the operation time of the battery as it is repeatedly used.
4. Even when the power is turned off, the printer battery will very gradually be consumed.
5. If you will not be using the printer for a long period of time, remove the battery from the printer.
6. Storing a battery with remaining charge for a long period of time may cause it to degrade. Please drain the power from the battery completely before storing it for long periods.

3.5 Charging the Battery

- (1) Be sure that the printer is turned off and AC plug is correct one. If AC plug is wrong, change the plug to correct one.
- (2) Open the DC Jack cover by pulling on the rubber cover and insert DC JACK into the printer.
- (3) Plug the power code to electrical outlet.
- (4) The Charge Indicator LED is on the AC Charger itself (not the printer) and shows red or green according to the status.

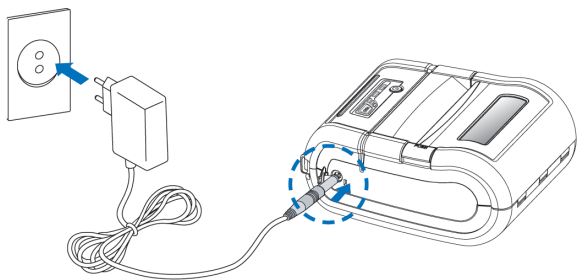

NOTE

In case of a trouble while charging the battery, the charge is suspended with charge LED blinking Red. Try unplugging and reconnecting charger, then charge should resume. The charging is completed when the LED changes to solid (continuous) green.

NOTE

1. Unless the exclusive charger is used provided by the manufacturer, the printer can be damaged, and the manufacturer is not liable for the consequential damage.
2. Before removing the battery, make sure that power is turned off.
3. A battery must be installed for printing. The printer will not operate from the charger alone.
4. It is not recommended to use or operate the printer whilst charging as it can reduce the battery's overall lifetime.

3.6 Removing Battery (with Belt Clip)

(1) Rotate the belt clip as shown.

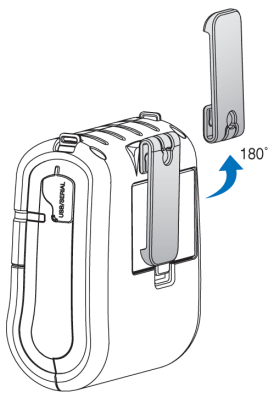

(2) Remove the battery as shown.

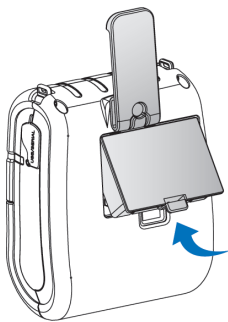

NOTE

Turn off the power before removing the battery.
Removing the battery with the power turned on may damage the printer due to static electricity etc.

3.7 Wireless Communication

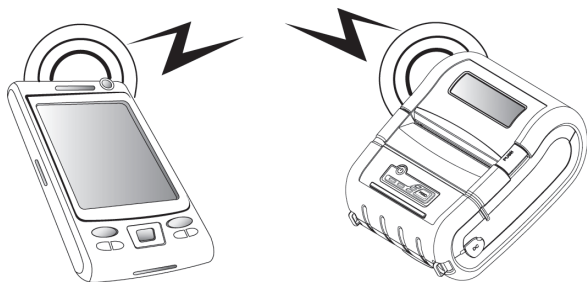

Bluetooth Connection

- (1) The Printer can be connected to devices equipped with a Bluetooth interface such as PDAs, PCs or mobile telephones and handheld scanners.
- (2) Use the Bluetooth connection function supported by the device to connect to the printer.
- (3) The default PIN code for pairing is "0000" but this can be changed with the Utilities supplied on the CD-ROM. Furthermore, enable/disable of Bluetooth Name/Discoverability/iOS auto connection can also be changed with the Utilities.
- (4) A printer found via Bluetooth is discovered with a Bluetooth name like CMP_xxxx. By default, xxxx is the last four digits of the Bluetooth address.
- (5) The pairing procedure differs depending on the communication partner.

NOTE

Bluetooth communication is slow so if a large data is printed, printing may stop intermittently and white streaks may appear in the part where printing stopped.

Bluetooth communication with iOS devices is even slower. If Bluetooth communication is not successful on Non-iOS devices, please try disabling iOS Auto Connection.

Wireless LAN Connection

- (1) The Printer can be connected to devices equipped with Wireless LAN connection according to the WiFi standards of 802.11a, 802.11b and .11g.
- (2) Use the WiFi(802.11a/b/g) connection function supported by the device to connect to the printer.

About Changing the Settings

Settings related to the wireless LAN can be changed with the Utilities supplied on the CD-ROM or in the settings screen that can be displayed by specifying the IP address of the printer in a browser.

The default SSID is CMP_xxxx with the xxxx part being the last four digits of the MAC address.

About the SoftAP Function

When this function is enabled, the printer functions as a simple access point. So it becomes possible to print directly from the host to the printer without an external access point.

When the SoftAP function is enabled, the Power LED always flashes.

 **NOTE**

1. Refer to Configuration Tool in the CD-ROM for the WiFi setting.
2. Interference with wireless LAN communication from other signals etc.
In regard to the use of wireless LAN in an environment that might experience interference from other signals, the following steps can be taken in order to restrict the chances of interference occurring.
 - Use an access point that is resistant to interference.
 - Change the placement of the devices, such as moving the wireless LAN device further away.
 - Use a different channel from the wireless LAN device.
 - Turn off the source of the interference.
 - Change other wireless LAN devices that support it to 5GHz.
3. Connecting to Wireless LAN Devices
There is a limit to the number of wireless LAN devices with which connection could be checked. There is no guarantee that connection will be possible with all wireless LAN devices.
Evaluate and check thoroughly prior to set up.
4. Security for Wireless Communication
Wireless communication carries with it certain risks, including interception of signals, leaking of communicated content and unauthorized access to your network.
Please give due consideration to security during its use.
Even if security issues such as leaks or unauthorized access do occur, our company shall bear no liability for any damages incurred as a result.

 **NOTE**

When there is an attempt to communicate with multiple interfaces, the interface that received data first is used. If the printer receives no data for 20 seconds, communication from another interface becomes possible.

3.8 Interface Cable Connection

- (1) Connect USB or Serial cable into the cable connector on the printer.

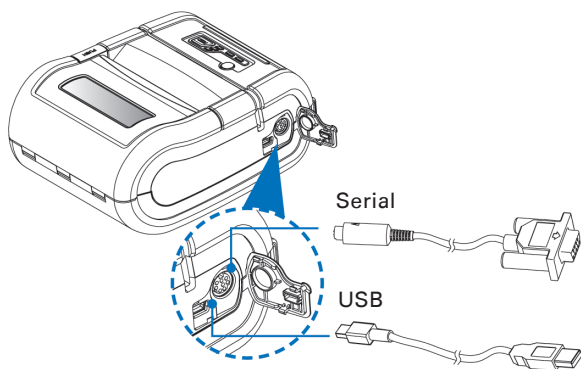

NOTE

Use the cable offered by the manufacturer (Serial).

- (2) Connect the interface cable into the USB or Serial port of the device (PDA, PC, etc.).

NOTE

If a host that is powered on is connected with a USB cable, the power of the printer turns on automatically.

NOTE

When there is an attempt to communicate with multiple interfaces, the interface that received data first is used. If the printer receives no data for 20 seconds, communication from another interface becomes possible.



NOTE

1. If the FEED button is pressed again within 3 seconds after printing ends, the mode switches to the hexadecimal dump print mode. If the FEED button is not pressed within 3 seconds, the self test ends automatically.
2. In the hexadecimal dump print mode, the received data is printed in hexadecimal format. To end the hexadecimal dump print mode, turn off the power.

3.10 Optimizing the Media Detection Level (Sensor Calibration)

If media loading detection is unstable, try performing sensor calibration. The procedure for sensor calibration is as follows.

- (1) Check that the emulation and sensor settings are appropriate.
- (2) Turn off the power.
In the case of label paper, peel off one label and make sure that the peeled part comes to the reflection sensor position.
- (3) Press the Power button while holding down the FEED button.
- (4) Continue pressing both buttons and then release the Power button when the Error LED goes out.
- (5) Keep holding down the FEED button till sensor optimization starts.

3.11 Power Save Mode, Auto Power Off

In order to extend the operating time of the battery, a mode is provided in which the printer will automatically switch to Power Save Mode or turn itself off if a certain amount of time passes without printing, communication or controls being performed.

Selecting which mode to use and the length of time after which it is activated is performed from the utility.

Auto Power Off will turn off the power entirely, therefore requiring the power to be turned back on before the printer can be used.

Power Save Mode will place certain printer functions into sleep mode.

Normal mode can be restored either by pressing the FEED button or by sending data to the printer.

The initial part of any data sent will be ignored, so start by sending a code of 2 bytes or more, such as a NULL that does not print anything or operate any function.

4. Utility, Drivers and SDK

4.1 Utility

Printer settings can be changed using the Windows software utility called "Printer Utility". The screen below is taken from the current version as of September 2016.

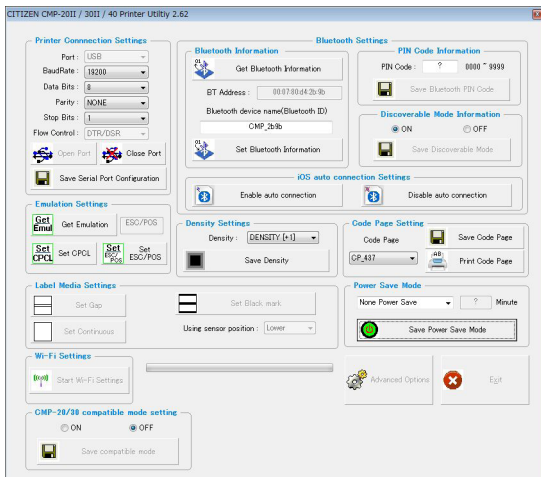

The latest version of the utility can be downloaded from http://www.citizen-systems.co.jp/support/download/printer/cmp20_30data/index_en.html

Settings can be changed using the following procedure.

(Select port ->) Connect -> Indicate/select new setting value -> Set -> Disconnect

See the utility manual for more details.

4.2 Printing via Driver or SDK

Sending printing to the printer from an application requires creation of print data and the transmission of data to the printer; generally, an easier way of performing this is using a driver or SDK.

A driver realizes printing in a format prepared by your OS. SDK realizes printing by embedding a unique printing format into the application. Support for drivers and SDK differs depending on your OS.

As of December 2013, OS support for the drivers and SDK for this printer is as follows.

OS that support drivers	Windows 2000/XP/Vista/7/8/10 and derivative OS Linux (CUPS) MacOS (CUPS)
OS that support SDK	Android (2.3.3 or higher) iOS WindowsCE4.2/5/6 and derivative OS

Even when using a supported OS, operation has not been confirmed in every possible environment. Please confirm operation for yourself.

The latest documentation relating to driver and SDK printing can be found on the same site as the utility.

5. Media specifications

5.1 Roll paper

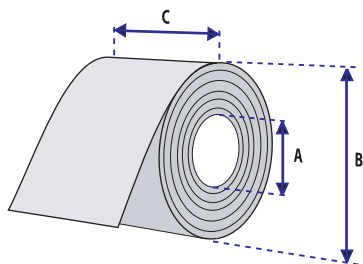

Core	
Diameter(A)	12.5 mm +/- 0.5 mm
Roll	
Max.diameter(B)	Max. Φ 56 mm
Media Width (C)	25.5 \pm 0.5 mm ~ 79.5 \pm 0.5 mm
Thickness	0.06 ~ 0.16 mm

NOTE

Protect the media against sand, grit, and other hard particles during printing and storage. Keep the cover closed. Even very small foreign particles may cause severe harm to the delicate printhead.

5.2 Label

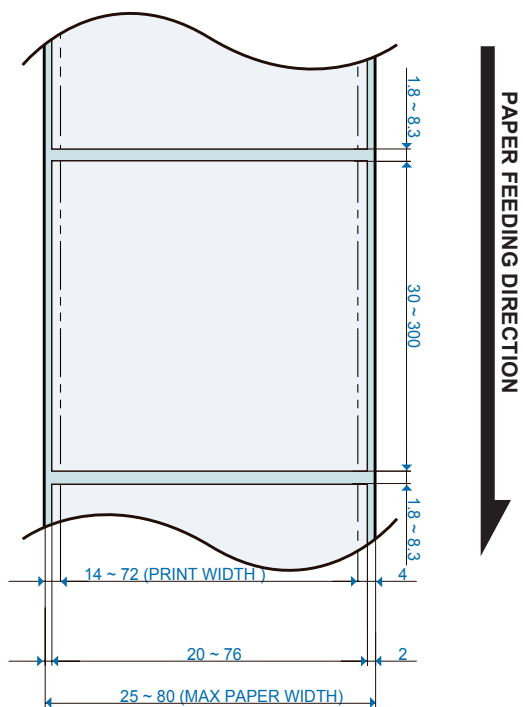

PRINTING AREA

5.3 Black mark

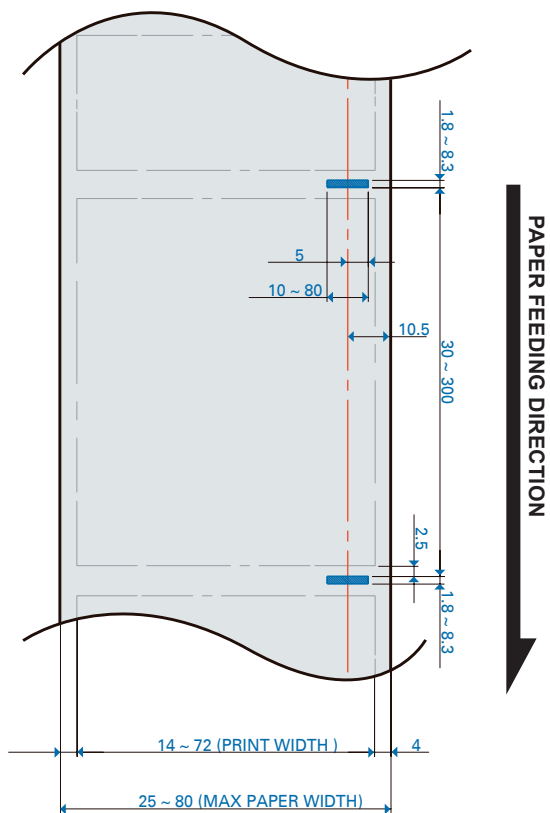

PRINTING AREA

CITIZEN SYSTEMS JAPAN CO., LTD.

6-1-12, Tanashi-cho, Nishi-Tokyo-shi Tokyo, 188-8511, Japan

Tel: +81 (0) 42 468 4608 Fax: +81 (0) 42 468 4687

<http://www.citizen-systems.co.jp>

CMP-30IIUM_100E
December 2016
PMC-1612