

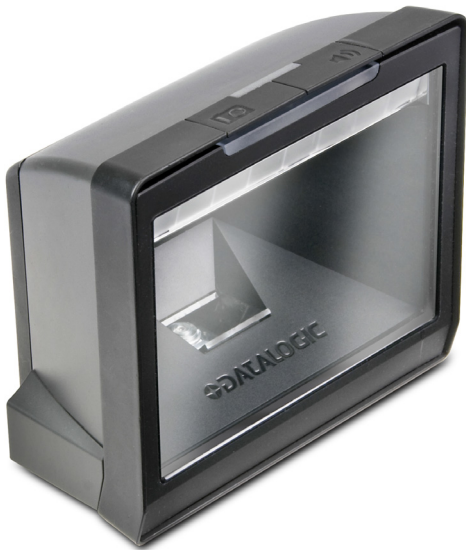

Magellan™ 3200VSi

Omni-Directional Imaging Scanner



Quick Reference Guide

Datalogic USA, Inc.

959 Terry Street
Eugene, OR 97402
USA
Telephone: (541) 683-5700
Fax: (541) 345-7140

© 2010 - 2017 Datalogic S.p.A. and its Group companies.

An Unpublished Work - All rights reserved. No part of the contents of this documentation or the procedures described therein may be reproduced or transmitted in any form or by any means without prior written permission of Datalogic S.p.A. or its subsidiaries or affiliates ("Datalogic" or "Datalogic USA, Inc."). Owners of Datalogic products are hereby granted a non-exclusive, revocable license to reproduce and transmit this documentation for the purchaser's own internal business purposes. Purchaser shall not remove or alter any proprietary notices, including copyright notices, contained in this documentation and shall ensure that all notices appear on any reproductions of the documentation.

Should future revisions of this manual be published, you can acquire printed versions by contacting your Datalogic representative. Electronic versions may either be downloadable from the Datalogic website (www.datalogic.com) or provided on appropriate media. If you visit our website and would like to make comments or suggestions about this or other Datalogic publications, please let us know via the "Contact Datalogic" page.

Disclaimer

Datalogic has taken reasonable measures to provide information in this manual that is complete and accurate, however, Datalogic reserves the right to change any specification at any time without prior notice.

Datalogic and the Datalogic logo are registered trademarks of Datalogic S.p.A. in many countries, including the U.S.A. and the E.U. All other brand and product names may be trademarks of Datalogic S.p.A. or of Datalogic Group companies, registered in many countries, including the U.S. and the E.U.

All other brand and product names may be trademarks of their respective owners.

Magellan is a trademark of Datalogic S.p.A. or of Datalogic Group companies, registered in many countries, including the U.S. and the E.U.

Patents

See www.patents.datalogic.com for patent list.

**See the Regulatory Addendum included with your product
for additional regulatory, safety and legal information.**

Quick Reference

Use this guide to quickly complete your installation and begin using your scanner. For more details, including programming information, reference the Product Reference Guide (PRG), which is available for viewing and download from the Datalogic website listed on the back cover of this manual.

Nomenclature

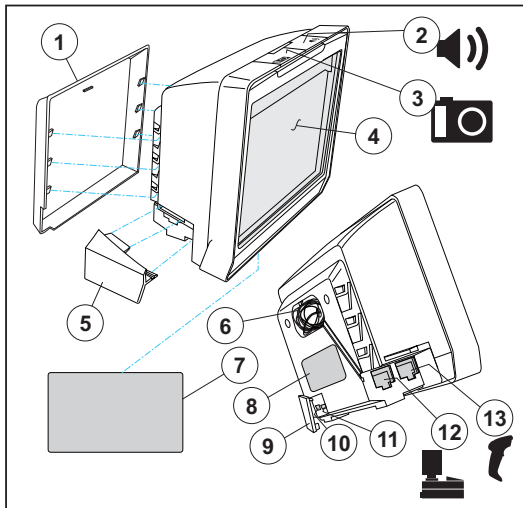

- | | |
|-----------------------------------|--|
| 1. Back Cover | 8. P/N Label |
| 2. Scanner Push Button | 9. USB/SD Cover |
| 3. Camera Push Button | 10. USB Test Port |
| 4. Scan Window | 11. SD Card Slot |
| 5. Cable Connector Cover | 12. Host (blue) Port |
| 6. Checkpoint EAS Wire Cavity | 13. Auxiliary (yellow) Port for handheld scanner, etc. |
| 7. Serial Number/Regulatory Label | |

Installation

Connect the scanner to the host (terminal) using the interface (I/F) cable as shown below. A cable from an older existing installation can be re-used if it uses Power Off the Terminal (POT), unless it is a USB POT cable. If external power is used/needed, plug the AC Adapter into the AC wall outlet, then connect it to the I/F cable as shown in 'b' and 'c' of the illustration.

Scan some known-good bar code samples to verify correct operation. The scanner should beep and/or flash its good read LED¹ and send the bar code data to the host or terminal. If not, use the Troubleshooting section of this guide to identify any problems.

Scanner installation is complete.

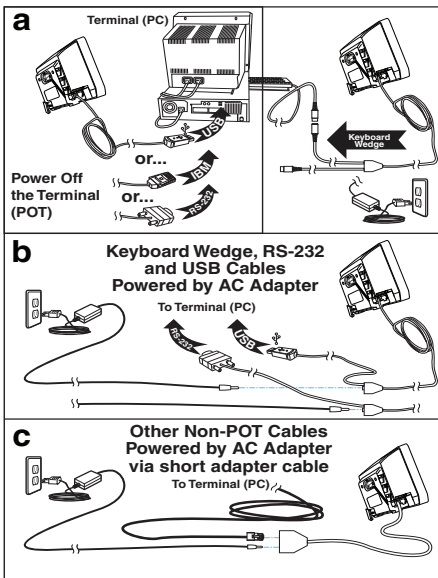

1. Be aware that beeper and LED behavior may have previously been configured as 'disabled' by another user.

How to Scan

Bar codes can either be presented to the scanner's window or pushed past it using a 'sweep' technique. The scanner can alternatively be programmed to initiate a scan of a cell phone or other LCD bar code object, or an image capture upon pushing the Camera Push Button. See the PRG for more details.



- 1. Product
- 2. Scan Window
- 3. Bar code
- 4. Sweeping motion
- 5. Presentation motion

Troubleshooting

Use this table to resolve common problems.

PROBLEM	SOLUTION
Scanner does not power on	Exchange the power supply with a known good power supply and retest operation.
No communication with the host	Consult your technical support personnel or refer to your host system manual to verify the proper interface type, cable and connection port(s) for the scanner. Verify the interface cable is securely attached to the host and the scanner.

PROBLEM	SOLUTION
The scanner will not read bar codes at all, or reads poorly	Make sure the window is clean. Check that the bar codes are of sufficient quality to be recognized by the scanner. Wrinkled, smudged, or torn labels can cause the scanner to not read at all. Scan known-good labels of an active symbology ³ to check the scanner's read operation.
If the scanner still does not function properly, consult the Product Reference Guide (PRG) or contact your local supplier or Datalogic Customer Support Services.	

- a. Reading of the various bar code symbologies can be independently enabled or disabled in the scanner.

Productivity Index Reporting™ Option

Your scanner may be equipped with the optional Productivity Index Reporting™ feature. This feature allows for data collection on the readability index of bar codes scanned by the scanner. This data may be transmitted to the POS Terminal, where it may be easily sorted for action by the MIS department to improve bar code quality at the front end. For additional information on how to enable Productivity Index Reporting in your scanner, please refer to the Product Reference Guide (PRG)

Scanner Push Button

The Scanner Push Button also performs multiple functions depending upon the duration of time it is pressed:



NOTE

Volume changes made using the Volume/Tone Push Button are lost when the scanner is powered down and are reset to the configured setting. If you wish to permanently change the volume, use the special programming labels in the Product Reference Guide.

Table 1. Scanner Push Button Functions

PRESS DURATION	FUNCTION	COMMENT
Momentary (when scanner is asleep)	Wakes scanner from Sleep Mode	Alternatively, the scanner can be awakened by: - Moving an object through the scan zone. - Scanning with an attached auxiliary scanner.
Momentary (when scanner is awake)	Increments volume	Press the push button momentarily to increase speaker volume. When the loudest volume is reached, a repeated press of the push button cycles volume back to the lowest setting, then volume increases on subsequent press(es). Four volume levels are available.
Hold, then release when the beeper sounds	Increments tone	Press the push button for approximately 2 seconds, then release. Each time this is done, the beeper will sound at one of three tones. Stop when the desired tone (high, medium or low) is sounded.
4 Seconds	Scanner Diagnostics Mode ^a	This mode allows system support personnel to troubleshoot problems with the scanner and is used to determine if it can read bar codes. Press the button for 8 seconds or cycle power to exit Scanner Diagnostics Mode and reset the scanner.
8 Seconds	Resets Scanner ^b	Only system support personnel should perform a reset.

- a. By standard default, this function is normally disabled to prevent accidental activation by users.
- b. Users should not perform scanner resets except under the direction of trained systems support personnel.

LED and Beeper Indicators

The scanner's beeper sounds and its green LED illuminates to indicate various functions or errors on the scanner. The tables below list these indications. An exception to the behaviors listed in the tables is that the scanner's functions are programmable, and may or may not be turned on. For example, certain indications, such as the power-up beep can be disabled using programming bar code labels.

Table 2. Green LED Indications

LED INDICATION	INDICATION	COMMENT
Power-on indication	Bright green flash	Indicates the scanner has finished all its power-up tests and is now ready for operation.
Good Read Indication	Bright green flash	Indicates a bar code has been read and decoded.
Scanner Ready	Constant dim green	The scanner is ready for operation.
Sleep Mode	Green LED slowly and continuously changes from off to dim to off.	The scanner is in Sleep Mode. To wake the scanner up, move an object in front of its window or press the button atop the unit. This indication is optionally configurable, and may have been programmed to behave differently.
Host Disable	Constant green flash at 1 Hz (100mS on, 900mS off)	The scanner is disabled due to receiving a disable command from the POS terminal.
Diagnostics	Varies (see Error Codes on page 8 for more information)	The LED can provide diagnostic feedback if the scanner discovers a problem during SelfTest.
Prog. Mode	See Host Disable above.	The scanner is in Programming Mode.

Table 3. Beeper Functions

BEEPER INDICATION	INDICATION	COMMENT
Power On Beep	Single beep	The Power-On LED indication is a configurable feature which can be enabled or disabled. When enabled, this beep indicates the scanner has finished all its power-up tests and is now ready for operation.
Good Read Indication	Single beep	The good read beep indication is configurable. Options include: Enable/disable, frequency, duration and volume. See the Product Reference Guide (PRG) for more information.
Diagnostics	Varies (see Error Codes on page 8 for more information)	The Beeper can provide diagnostic feedback if the scanner discovers a problem during SelfTest.
Programming Mode Indications	Varies depending upon the feature(s) being configured.	The Beeper will sound as programming bar code labels are scanned, indicating progress during scanner configuration.

Error Codes

If an error is detected, the scanner will sound a long low tone (for three seconds) and flash its LED, indicating a failure. When this occurs, press the Scanner Push button to hear the error code. If it is configured to do so, the scanner will sound a series of beeps corresponding to the error code and/or flash its LED simultaneous to the beeps. The table below describes what these codes mean and what action should be taken for each.

NUMBER OF LED FLASHES/ BEEPS	ERROR	CORRECTIVE ACTION
1	Configuration	Contact Helpdesk for assistance
2	Interface PCB	
4	Imager	
6	Main PCB	
10	Button Error	
11	Hardware ID	
12	Model ID	
13	CPLD ID	

Going Green

Thank you for using the bar code mask on the opposite side of this page. This manual has been formatted to minimize the quantity of pages needed to provide the programming bar codes available for this product.



Bar Code Mask

Cut a hole in this page and remove it from the manual as indicated to create a sleeve through which bar codes (on the following pages) can be individually viewed and scanned. It is important that only one bar code at a time be presented to the scanner.

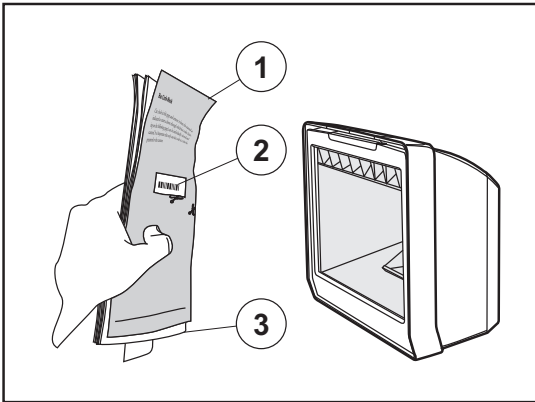
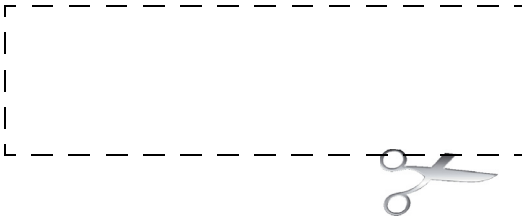

1. Bar Code Mask Sheet
2. Bar Code
3. Manual (folded)

Programming

Upon completing the physical connection between the reader and its host, proceed directly to the Programming Bar Codes table below to locate the interface type the reader is connected to (for example: RS-232, Keyboard Wedge, USB, etc.).

Use the Bar Code Mask on the preceding page to isolate the bar code you intend to scan. Scan a START/END bar code once to enter Programming Mode. After selecting (scanning) the interface, scan the START/END bar code a second time, which will then accept your changes, exit Programming Mode and return the reader to normal operation.

You can select other options and customize your reader through use of the instructions and programming bar codes available in the PRG, or use the On Screen Programming (OSP) utility available from the website listed on the back cover of this manual.

 START / END
PROGRAMMING BAR CODES
 RS-232 Standard
 RS-232 Wincor-Nixdorf
 IBM 4683 Port 5B



START / END



IBM 4683 Port 9B



IBM 4683 Port 17



USB-OEM



USB Keyboard

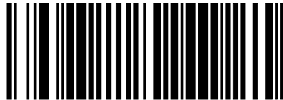

USB COM Interface



Keyboard Wedge A (PC/XT w/alternate Key Encoding)



NOTE

If other than Keyboard Wedge A with USA keyboard is needed, see the PRG or On Screen Programming for additional options.

Cleaning

Exterior surfaces and scan windows exposed to spills, smudges or debris accumulation require periodic cleaning to assure best performance during scanning. Use a clean, lint-free cloth or paper towel dampened with a nonabrasive, mild, water-based window cleaner to wipe away stains, smudges, fingerprints, spills, etc. from the scan window and exterior surfaces.

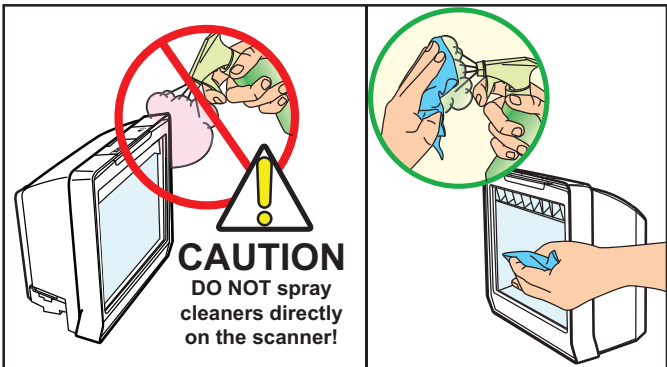

CAUTION

DO NOT use abrasive cleaning agents or abrasive pads to clean this product. Harsh chemicals, disinfectants, and cleansers can cause damage which will adversely affect scanning performance.

NOTES

Warranty

Datalogic warrants to Customer that this product will be free from defects in materials and workmanship for a period of 3 years from product shipment.

Datalogic USA Limited Factory Warranty

Warranty Coverage

Datalogic USA ('Datalogic') hardware products are warranted against defects in material and workmanship under normal and proper use. The liability of Datalogic under this warranty is limited to furnishing the labor and parts necessary to remedy any defect covered by this warranty and restore the product to its normal operating condition. Repair or replacement of product during the warranty does not extend the original warranty term. Products are sold on the basis of specifications applicable at the time of manufacture and Datalogic has no obligation to modify or update products once sold.

If Datalogic determines that a product has defects in material or workmanship, Datalogic shall, at its sole option repair or replace the product without additional charge for parts and labor, or credit or refund the defective products duly returned to Datalogic. To perform repairs, Datalogic may use new or reconditioned parts, components, subassemblies or products that have been tested as meeting applicable specifications for equivalent new material and products. Customer will allow Datalogic to scrap all parts removed from the repaired product. The warranty period shall extend from the date of shipment from Datalogic for the duration published by Datalogic for the product at the time of purchase (Warranty period). Datalogic warrants repaired hardware devices against defects in workmanship and materials on the repaired assembly for a 90 day period starting from the date of shipment of the repaired product from Datalogic or until the expiration of the original warranty period, whichever is longer. Datalogic does not guarantee, and it is not responsible for, the maintenance of, damage to, or loss of configurations, data, and applications on the repaired units and at its sole discretion can return the units in the 'factory default' configuration or with any software or firmware update available at the time of the repair (other than the firmware or software installed during the manufacture of the product). Customer accepts responsibility to maintain a backup copy of its software and data.

Warranty Claims Process

In order to obtain service under the Factory Warranty, Customer must notify Datalogic of the claimed defect before the expiration of the applicable Warranty period and obtain from Datalogic a return authorization number (RMA) for return of the product to a designated Datalogic service center. If Datalogic determines Customer's claim is valid, Datalogic will repair or replace product without additional charge for parts and labor. Customer shall be responsible for packaging and shipping the product to the designated Datalogic service center, with shipping charges prepaid. Datalogic shall pay for the return of the product to Customer if the shipment is to a location within the country in which the Datalogic service center is located. Customer shall be responsible for paying all shipping charges, duties, taxes, and any other charges for products returned to any other locations. Failure to follow the applicable RMA policy, may result in a processing fee. Customer shall be responsible for return shipment expenses for products which Datalogic, at its sole discretion, determines are not defective or eligible for warranty repair.

Warranty Exclusions

The Datalogic Factory Warranty shall not apply to:

- (i) any product which has been damaged, modified, altered, repaired or upgraded by other than Datalogic service personnel or its authorized representatives;
- (ii) any claimed defect, failure or damage which Datalogic determines was caused by faulty operations, improper use, abuse, misuse, wear and tear, negligence, improper storage or use of parts or accessories not approved or supplied by Datalogic;
- (iii) any claimed defect or damage caused by the use of product with any other instrument, equipment or apparatus;
- (iv) any claimed defect or damage caused by the failure to provide proper maintenance, including but not limited to cleaning the upper window in accordance with product manual;
- (v) any defect or damage caused by natural or man-made disaster such as but not limited to fire, water damage, floods, other natural disasters, vandalism or abusive events that would cause internal and external component damage or destruction of the whole unit, consumable items;
- (vi) any damage or malfunctioning caused by non-restoring action as for example firmware or software upgrades, software or hardware reconfigurations etc.;
- (vii) the replacement of upper window / cartridge due to scratching, stains or other degradation and/or
- (viii) any consumable or equivalent (e.g., cables, power supply, batteries, keypads, touch screen, triggers etc.).

No Assignment

Customer may not assign or otherwise transfer its rights or obligations under this warranty except to a purchaser or transferee of product. No attempted assignment or transfer in violation of this provision shall be valid or binding upon Datalogic.

DATALOGIC'S LIMITED WARRANTY IS IN LIEU OF ALL OTHER WARRANTIES, EXPRESS OR IMPLIED, ORAL OR WRITTEN, STATUTORY OR OTHERWISE, INCLUDING, WITHOUT LIMITATION, ANY IMPLIED WARRANTIES OF MERCHANTABILITY, FITNESS FOR A PARTICULAR PURPOSE, OR NONINFRINGEMENT. DATALOGIC SHALL NOT BE LIABLE FOR ANY DAMAGES SUSTAINED BY CUSTOMER ARISING FROM DELAYS IN THE REPLACEMENT OR REPAIR OF PRODUCTS UNDER THE ABOVE. THE REMEDY SET FORTH IN THIS WARRANTY STATEMENT IS THE CUSTOMER'S SOLE AND EXCLUSIVE REMEDY FOR WARRANTY CLAIMS. UNDER NO CIRCUMSTANCES WILL DATALOGIC BE LIABLE TO CUSTOMER OR ANY THIRD PARTY FOR ANY LOST PROFITS, OR ANY INCIDENTAL, CONSEQUENTIAL IN-DIRECT, SPECIAL OR CONSEQUENTIAL DAMAGES REGARDLESS OF WHETHER DATALOGIC HAD ADVANCE NOTICE OF THE POSSIBILITY OF SUCH DAMAGES.

Risk of Loss

Customer shall bear risk of loss or damage for product in transit to Datalogic. Datalogic shall assume risk of loss or damage for product in Datalogic's possession. In the absence of specific written instructions for the return of product to Customer, Datalogic will select the carrier, but Datalogic shall not thereby assume any liability in connection with the return shipment.



© 2010–2017 Datalogic S.p.A. and its Group companies ■ All rights reserved. ■ Protected to the fullest extent under U.S. and international laws. ■ Copying or altering of this document is prohibited without express written consent from Datalogic S.p.A. ■ Datalogic and the Datalogic logo are registered trademarks of Datalogic S.p.A. in many countries, including the U.S. and the E.U.



www.datalogic.com

Datalogic USA, Inc.

959 Terry Street | Eugene | OR 97402 | USA

Telephone: (1) 541-683-5700 | Fax: (1) 541-345-7140



820085914 (Rev. E) Jan 2017