

TC200/ TC210/ TC300/ TC310 Series

**THERMAL TRANSFER / DIRECT THERMAL
BAR CODE PRINTER**

**USER'S
MANUAL**

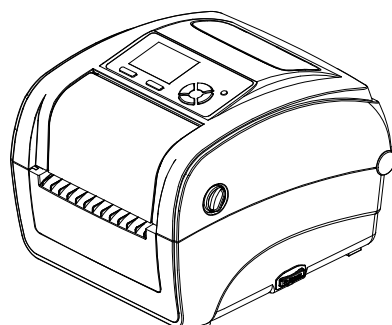
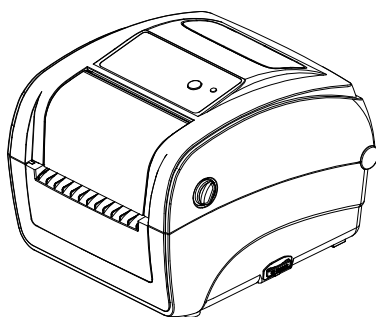

Copyright Information

©2015 TSC Auto ID Technology Co., Ltd.

The copyright in this manual, the software and firmware in the printer described therein are owned by TSC Auto ID Technology Co., Ltd, All rights reserved.

CG Triumvirate is a trademark of Agfa Corporation. CG Triumvirate Bold Condensed font is under license from the Monotype Corporation. Windows is a registered trademark of Microsoft Corporation.

All other trademarks are the property of their respective owners.

Information in this document is subject to change without notice and does not represent a commitment on the part of TSC Auto ID Technology Co. No part of this manual may be reproduced or transmitted in any form or by any means, for any purpose other than the purchaser's personal use, without the expressed written permission of TSC Auto ID Technology Co.

Agency Compliance and Approvals



EN 55032, Class B
EN 55024
EN 60950-1;
EN 61000-3-2; EN 61000-3-3

FCC part 15B, Class B
ICES-003, Class B

This equipment has been tested and found to comply with the limits for a Class B digital device, pursuant to part 15 of the FCC Rules. These limits are designed to provide reasonable protection against harmful interference in a residential installation. This equipment generates, uses and can radiate radio frequency energy and, if not installed and used in accordance with the instructions, may cause harmful interference to radio communications. However, there is no guarantee that interference will not occur in a particular installation. If this equipment does cause harmful interference to radio or television reception, which can be determined by turning the equipment off and on, the user is encouraged to try to correct the interference by one or more of the following measures:



- Reorient or relocate the receiving antenna.
- Increase the separation between the equipment and receiver.
- Connect the equipment into an outlet on a circuit different from that to which the receiver is connected.
- Consult the dealer or an experienced radio/ TV technician for help.

This device complies with Part 15 of the FCC Rules. Operation is subject to the following two conditions: (1) This device may cause harmful interference, and (2) this device must accept any interference received, including interference that may cause undesired operation.

This Class B digital apparatus complies with Canadian ICES-003.

Cet appareil numérique de la classe B est conforme à la norme NMB-003 du Canada.



AS/NZS CISPR 32, Class B



UL 60950-1(2nd Edition)
CSA C22.2 No. 60950-1-07(2nd Edition)



EN 60950-1



GB 4943.1

GB 9254, Class B

GB 17625.1



Energy Star for Imaging Equipment Version 2.0

Note: There may have certification differences in the series models, please refer to product label for accuracy.

Important safety instructions:

1. Read all of these instructions and keep them for later use.
2. Follow all warnings and instructions on the product.
3. Disconnect the power plug from the AC outlet before cleaning or if fault happened.

Do not use liquid or aerosol cleaners. Using a damp cloth is suitable for cleaning.

4. The mains socket shall be installed near the equipment and easily accessible.
5. The unit must be protected against moisture.
6. Ensure the stability when installing the device, Tipping or dropping could cause damage.
7. Make sure to follow the correct power rating and power type indicated on marking label

provided by manufacture.

8. Please refer to user manual for maximum operation ambient temperature.

WARNING:

Hazardous moving parts, keep fingers and other body parts away.

CAUTION:

(For equipment with RTC (CR2032) battery or rechargeable battery pack)

Risk of explosion if battery is replaced by an incorrect type.

Dispose of used batteries according to the Instructions as below.

1. DO NOT throw the battery in fire.
2. DO NOT short circuit the contacts.
3. DO NOT disassemble the battery.
4. DO NOT throw the battery in municipal waste.
5. The symbol of the crossed out wheeled bin indicates that the battery should not be placed in municipal waste.



Caution: The printhead may be hot and could cause severe burns. Allow the printhead to cool.

CAUTION:

Any changes or modifications not expressly approved by the grantee of this device could void the user's authority to operate the equipment.

Contents

- 1. Introduction1
 - 1.1 Product Introduction1
 - 1.2 Product Features2
 - 1.2.1 Printer Standard Features** 2
 - 1.2.2 Printer Optional Features** 4
 - 1.3 General Specifications5
 - 1.4 Print Specifications5
 - 1.5 Ribbon Specifications5
 - 1.6 Media Specifications6
- 2. Operations Overview7
 - 2.1 Unpacking and Inspection7
 - 2.2 Printer Overview8
 - 2.2.1 Front View** 8
 - 2.2.2 Interior view** 10
 - 2.2.3 Rear View** 11
 - 2.3 Operator Control 12
 - 2.3.1 LED Indication** 12
 - 2.3.2 Button Function** 12
- 3. Setup 13
 - 3.1 Setting up the printer 13
 - 3.2 Open/Close the Top Cover 14
 - 3.3 Loading the Ribbon 15
 - 3.4 Loading the Media 18
 - 3.4.1 Loading the Media** 18
 - 3.4.2 Loading the Fan-fold Media** 21
 - 3.4.3 External Label Roll Mount Installation (Option)** 23
 - 3.4.4 Loading Media in Peel-off Mode (Option)** 25
 - 3.4.5 Loading Media in Cutter Mode (Option)** 27
- 4. Diagnostic Tool 28
 - 4.1 Start the Diagnostic Tool 28

| | |
|---|----|
| 4.2 Printer Function | 29 |
| 4.3 Setting Ethernet by Diagnostic Tool | 30 |
| 4.3.1 Using USB interface to setup Ethernet interface | 30 |
| 4.3.2 Using RS-232 interface to setup Ethernet interface | 31 |
| 4.3.3 Using Ethernet interface to setup Ethernet interface | 32 |
| 5. Power-on Utilities | 34 |
| 5.1 Ribbon and Gap/Black Mark Sensor Calibration | 35 |
| 5.2 Gap/Black Mark Calibration, Self-test and Dump Mode | 36 |
| 5.3 Printer Initialization | 40 |
| 5.4 Set Black Mark Sensor as Media Sensor and Calibrate the Black Mark Sensor 41 | |
| 5.5 Set Gap Sensor as Media Sensor and Calibrate the Gap Sensor | 42 |
| 5.6 Skip AUTO.BAS | 43 |
| 6. LCD Menu Function | 44 |
| 6.1 Enter the Menu | 44 |
| 6.2 Main Menu Overview | 45 |
| 6.3 TSPL2 | 46 |
| 6.4 ZPL2 | 48 |
| 6.5 Sensor | 51 |
| 6.6 Interface | 52 |
| 6.6.1 Serial Comm. | 52 |
| 6.6.2 Ethernet | 53 |
| 6.6.3 Bluetooth | 54 |
| 6.6.4 Wi-Fi | 54 |
| 6.7 File Manager | 55 |
| 6.8 Diagnostics | 56 |
| 6.8.1 Print Config. | 56 |
| 6.8.2 Dump Mode | 58 |
| 6.8.3 Print Head | 59 |
| 6.8.4 Display | 59 |
| 6.8.5 Sensor | 59 |
| 6.9 Advanced | 60 |
| 6.10 Service | 61 |

7. Troubleshooting 62

8. Maintenance 65

Revise History 67

1. Introduction

1.1 Product Introduction

Thank you very much for purchasing TSC bar code printer.

The TC200/210 series of thermal transfer desktop barcode printer, label printer with its new, smaller footprint, offers the high performance that customers have come to expect from TSC™. Durable, reliable and fast, the TC200/210 generates 4-inch-wide labels, tags or receipts at up to 6 ips, offering a price-performance combination that is unmatched by other desktop thermal barcode printers on the market.

As with all TSC printers, the TC200/210 series features the TSPL-EZ™ printer-control language, which is fully compatible with other TSC printer languages, while supporting TPLE (Translation Printer Language Eltron®) and TPLZ (Translation Printer Language Zebra®). The languages automatically decipher and translate the format of each label as it is sent to the printer. TSPL-EZ™ also features internal scalable True Type fonts (based on the Monotype® font engine), which are typically found only in more expensive printers.

Applications:

- Point-of-sale
- Product marking
- Receipt/ coupon printing
- Compliance labeling
- Asset tracking
- Document management
- Shipping/ receiving
- Inventory control
- Specimen labeling
- Patient tracking

1.2 Product Features

1.2.1 Printer Standard Features

The printer offers the following standard features.

| Product standard feature | TC200/TC300 model | TC210/TC310 model |
|---|-------------------|-------------------|
| Thermal transfer/ or direct thermal | ○ | ○ |
| 1 operating button and 1 LED with 3 colors | ○ | - |
| 6 operating buttons and 1 LED with 3 colors | - | ○ |
| 320 x 240 TFT LCD (UI of operating menu) | - | ○ |
| 32-bit RISC high performance processor (Atmel 9260/ 210 MHz) | ○ | - |
| 32-bit RISC high performance processor (Atmel 9G25/ 400 MHz) | - | ○ |
| Center alignment holder with spiral spring | ○ | ○ |
| Gap transmissive sensor (Fixed, center of offset 4 from center) | ○ | ○ |
| Black mark reflective sensor (Position adjustable) | ○ | ○ |
| Ribbon encoder sensor | ○ | ○ |
| Head open sensor | ○ | ○ |
| Automatic media/ribbon sensor selecting | ○ | ○ |
| 4 MB Flash memory | ○ | - |
| 128 MB Flash memory | - | ○ |
| 8 MB DRAM | ○ | - |
| 64 MB DDR2 DRAM | - | ○ |
| SD card reader for memory expansion, up to 4 GB | ○ | - |
| SD card reader for memory expansion, up to 32 GB | - | ○ |
| RS-232 interface (Max. 115,200 bps) | ○ | ○ |
| USB 2.0 interface (Full speed mode) | ○ | - |
| USB 2.0 interface (Hi speed mode) | - | ○ |
| Internal Ethernet print server (10/100 Mbps) interface | ○ | ○ |
| USB host | - | ○ |
| Parallel (SPP mode) | ○ | - |
| Standard industry emulations right out of the box including Eltron® and Zebra® language support | ○ | ○ |
| Internal 8 alpha-numeric bitmap fonts | ○ | ○ |
| Fonts and bar codes can be printed in any one of the four directions (0, 90, 180, 270 degree) | ○ | ○ |
| Internal Monotype Imaging® true type font engine with one CG Triumvirate Bold Condensed scalable font | ○ | ○ |
| Downloadable fonts from PC to printer memory | ○ | ○ |
| Unicode UTF8 support | ○ | ○ |

| Bar code, graphics/image printing | | | | | | | | | | | |
|---|--|---|--|-----------------|-------------|-------------|---|---|--|--|--|
| <table border="1"> <thead> <tr> <th colspan="2">Supported bar code</th> <th>Supported image</th> </tr> </thead> <tbody> <tr> <td>1D bar code</td> <td>2D bar code</td> <td rowspan="2"> BITMAP, BMP, PCX (Max. 256 colors graphics) </td> </tr> <tr> <td> Code128 subsets A.B.C, Code128UCC, EAN128, Interleave 2 of 5, Code 39, Code 93, EAN- 13, EAN-8, Codabar, POSTNET, UPC-A, UPC- E, EAN and UPC 2(5) digits, MSI, PLESSEY, China Post, ITF14, EAN14, Code 11, TELPEN, PLANET, Code 49, Deutsche Post Identcode, Deutsche Post Leitcode, LOGMARS </td> <td> CODABLOCK F mode, DataMatrix, Maxicode, PDF-417, Aztec, MicroPDF417, QR code, RSS Barcode (GS1 Databar) </td> </tr> </tbody> </table> | | Supported bar code | | Supported image | 1D bar code | 2D bar code | BITMAP, BMP, PCX (Max. 256 colors graphics) | Code128 subsets A.B.C, Code128UCC, EAN128, Interleave 2 of 5, Code 39, Code 93, EAN- 13, EAN-8, Codabar, POSTNET, UPC-A, UPC- E, EAN and UPC 2(5) digits, MSI, PLESSEY, China Post, ITF14, EAN14, Code 11, TELPEN, PLANET, Code 49, Deutsche Post Identcode, Deutsche Post Leitcode, LOGMARS | CODABLOCK F mode, DataMatrix, Maxicode, PDF-417, Aztec, MicroPDF417, QR code, RSS Barcode (GS1 Databar) | | |
| Supported bar code | | Supported image | | | | | | | | | |
| 1D bar code | 2D bar code | BITMAP, BMP, PCX (Max. 256 colors graphics) | | | | | | | | | |
| Code128 subsets A.B.C, Code128UCC, EAN128, Interleave 2 of 5, Code 39, Code 93, EAN- 13, EAN-8, Codabar, POSTNET, UPC-A, UPC- E, EAN and UPC 2(5) digits, MSI, PLESSEY, China Post, ITF14, EAN14, Code 11, TELPEN, PLANET, Code 49, Deutsche Post Identcode, Deutsche Post Leitcode, LOGMARS | CODABLOCK F mode, DataMatrix, Maxicode, PDF-417, Aztec, MicroPDF417, QR code, RSS Barcode (GS1 Databar) | | | | | | | | | | |
| Supported code page: <ul style="list-style-type: none"> ▪ Codepage 437 (English - US) ▪ Codepage 737 (Greek) ▪ Codepage 850 (Latin-1) ▪ Codepage 852 (Latin-2) ▪ Codepage 855 (Cyrillic) ▪ Codepage 857 (Turkish) ▪ Codepage 860 (Portuguese) ▪ Codepage 861 (Icelandic) ▪ Codepage 862 (Hebrew) ▪ Codepage 863 (French Canadian) ▪ Codepage 864 (Arabic) ▪ Codepage 865 (Nordic) ▪ Codepage 866 (Russian) ▪ Codepage 869 (Greek 2) ▪ Codepage 950 (Traditional Chinese) ▪ Codepage 936 (Simplified Chinese) ▪ Codepage 932 (Japanese) ▪ Codepage 949 (Korean) ▪ Codepage 1250 (Latin-2) ▪ Codepage 1251 (Cyrillic) ▪ Codepage 1252 (Latin-1) ▪ Codepage 1253 (Greek) ▪ Codepage 1254 (Turkish) ▪ Codepage 1255 (Hebrew) ▪ Codepage 1256 (Arabic) ▪ Codepage 1257 (Baltic) ▪ Codepage 1258 (Vietnam) | | | | | | | | | | | |

| | | |
|--|--|--|
| <ul style="list-style-type: none"> • ISO-8859-1: Latin-1 (Western European) • ISO-8859-2: Latin-2 (Central European) • ISO-8859-3: Latin-3 (South European) • ISO-8859-4: Latin-4 (North European) • ISO-8859-5: Cyrillic • ISO-8859-6: Arabic • ISO-8859-7: Greek • ISO-8859-8: Hebrew • ISO-8859-9: Turkish • ISO-8859-10: Nordic • ISO-8859-15: Latin-9 • UTF-8 | | |
|--|--|--|

1.2.2 Printer Optional Features

The printer offers the following optional features.

| Product option feature | User option | Dealer option | Factory option |
|---|-------------|---------------|----------------|
| Peel-off kit <i>Paper length: 1" ~ 6"</i> <i>Note:</i> <i>This peel-off module is supported for the thermal/ plain label only.</i> | | ○ | |
| Regular cutter (full cut guillotine cutter) <i>Media thickness: 0.06~ 0.19 mm</i> <i>Media length: 1" ~ max. length</i> <i>Max. width: 110 mm</i> <i>Media type: receipt and label liner w/o glue</i> <i>Note:</i> <i>Except for the linerless cutter, all regular/heavy duty/care label cutters DO NOT cut on media with glue.</i> | | ○ | |
| KP-200 Plus keyboard display unit | ○ | | |
| KU-007 Plus programmable smart keyboard | ○ | | |
| External roll mount with 3" core label spindle | ○ | | |
| Sleeve adapter | ○ | | |
| External Bluetooth module (serial interface) | ○ | | |
| External 802.11 b/g/n wireless module (serial interface) | ○ | | |
| Parallel port for TC210/TC310 series (replace USB host) | | | ○ |
| Real time clock & Buzzer | | | ○ |

1.3 General Specifications

| General Specifications | |
|--------------------------------|--|
| Physical dimensions | 203 mm(W) x 191.5 mm(H) x 259.3 mm(D) |
| Weight | TC200/TC300: 2.2 kg TC210/TC310: 2.3 kg |
| Mechanism | Clamshell with Double-walled plastic |
| Power | External universal switching power supply • Input: AC 100-240V/ 2.5A, 50-60 Hz • Output: DC 24V/ 3.75A, 90W |
| Environmental condition | Operation: 5 ~ 40°C (41 ~ 104°F), 25~85% non-condensing Storage: -40 ~ 60 °C (-40 ~ 140°F), 10~90% non-condensing |
| Environmental concern | Comply with RoHS, WEEE, REACH |

1.4 Print Specifications

| Print Specifications | TC200 | TC210 | TC300 | TC310 |
|---|--|----------------------|--------------------------------------|---------------------|
| Print head resolution (dots per inch/mm) | 203 dots/inch (8 dots/mm) | | 300 dots/inch (12 dots/mm) | |
| Printing method | Thermal transfer/ or direct thermal | | | |
| Dot size (width x length) | 0.125 x 0.125 mm (1 mm = 8 dots) | | 0.084 x 0.084 mm (1 mm = 12 dots) | |
| Print speed (inches per second) | Up to 6 IPS | | Up to 4 IPS | |
| | Max. 3 ips for peeler mode | | | |
| Max. print width | 108 mm (4.25") | | 105.6 mm (4.15") | |
| Max. print length | 2,286 mm (90") | 25,400 mm (1000") | 1,016 mm (40") | 11,430 mm (450") |
| Printout bias | Vertical: 1 mm max. Horizontal: 1 mm max. | | | |

1.5 Ribbon Specifications

| Ribbon Specifications | |
|------------------------------------|--------------------------|
| Ribbon outside diameter | Max. 40 mm OD |
| Ribbon length | 110 meter |
| Ribbon core inside diameter | 0.5" ID core |
| Ribbon width | 40 mm ~110 mm |
| Ribbon wound type | Ink coated outside wound |

1.6 Media Specifications

| Media Specifications | |
|-----------------------------------|---|
| Media roll capacity | Max. 5" OD |
| Media core diameter | 1" & 1.5 ID core |
| Media type | Continuous, die-cut, black mark, external fan-fold, notch |
| Media wound type | Outside wound |
| Media width | 20 mm ~ 112 mm |
| Media thickness | 0.06 mm ~ 0.19 mm |
| Label length | 10 mm ~ max. print length |
| Label length (peeler mode) | 25.4 mm ~ 152.4 mm (1" ~ 6") |
| Label length (cutter mode) | 25.4 ~ max. print length |
| Black mark | Min. 8 mm (W) x 2 mm (H) |
| Gap height | Min. 2 mm |

2. Operations Overview

2.1 Unpacking and Inspection

This printer has been specially packaged to withstand damage during shipping. Please carefully inspect the packaging and printer upon receiving the bar code printer. Please retain the packaging materials in case you need to reship the printer.

Unpacking the printer, the following items are included in the carton.

- One printer unit
- One Windows labeling software/Windows driver CD disk
- One quick installation guide
- One power cord
- One auto switching power supply
- One USB interface cable

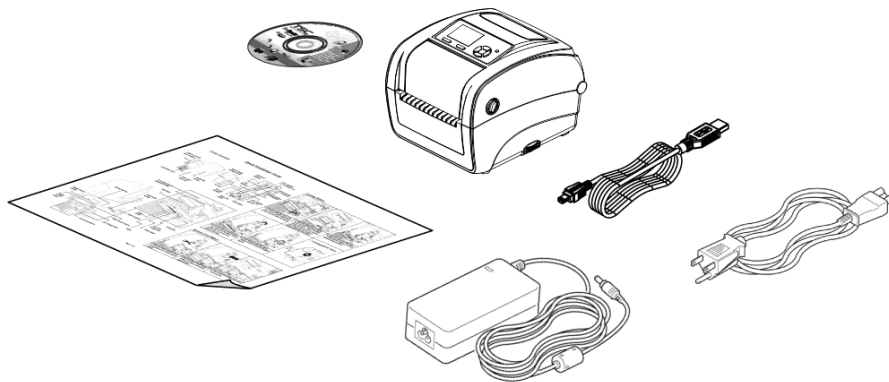

If any parts are missing, please contact the Customer Service Department of your purchased reseller or distributor.

2.2 Printer Overview

2.2.1 Front View

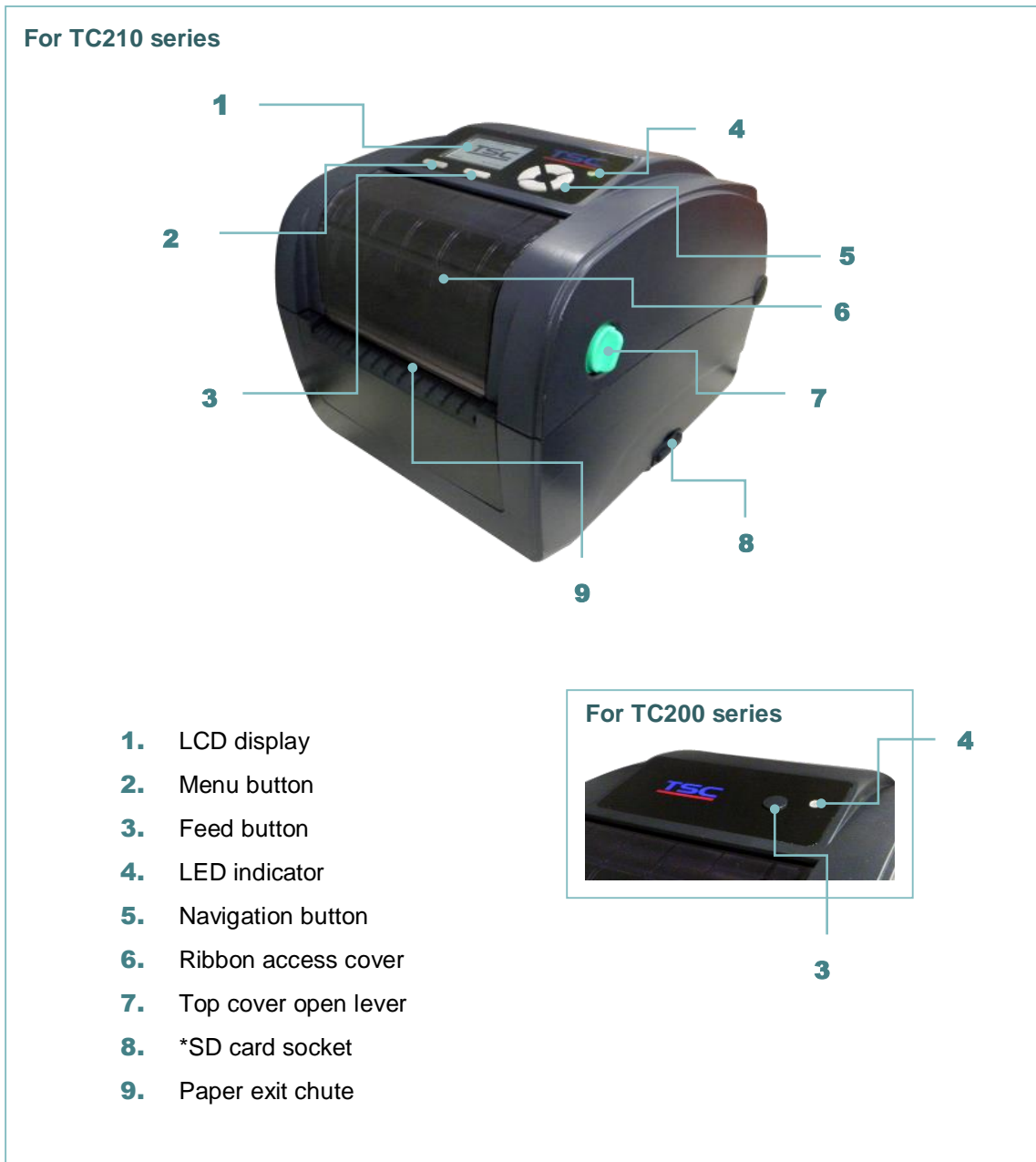

* Recommended SD card specification.

For TC210 series

| SD card spec | SD card capacity | Approved SD card manufacturer |
|-------------------|------------------|-------------------------------|
| V2.0 SDHC CLASS 4 | 2 GB | Transcend |
| V2.0 SDHC CLASS 4 | 8 GB | SanDisk |
| V3.0 CLASS 10 UHS | 16 GB | SanDisk |
| V3.0 CLASS 10 UHS | 32 MB | Transcend |
| V2.0 SDHC CLASS 4 | microSD 4GB | Transcend |

| | | |
|---|---------------|---------------------|
| V2.0 SDHC CLASS 4 | microSD 16 GB | SanDisk |
| V3.0 CLASS 10 UHS | microSD 16GB | Transcend, Kingston |
| V3.0 CLASS 10 UHS | microSD 32 GB | SanDisk |
| <ul style="list-style-type: none"> - The DOS FAT file system is supported for the SD card. - Folders/files stored in the SD card should be in the 8.3 filename format - The miniSD/microSD card to SD card slot adapter is required. | | |

For TC200 series

| SD card spec | SD card capacity | Approved SD card manufacturer |
|---|------------------|-------------------------------|
| V1.0, V1.1 | 128 MB | SanDisk, Transcend |
| V1.0, V1.1 | 256 MB | SanDisk, Transcend, Panasonic |
| V1.0, V1.1 | 512 MB | SanDisk, Transcend, Panasonic |
| V1.0, V1.1 | 1 GB | SanDisk, Transcend, Panasonic |
| V2.0 SDHC CLASS 4 | 4 GB | |
| V2.0 SDHC CLASS 6 | 4 GB | SanDisk, Transcend, Panasonic |
| V1.0, V1.1 | microSD 128 MB | Transcend, Panasonic |
| V1.0, V1.1 | microSD 256 MB | Transcend, Panasonic |
| V1.0, V1.1 | microSD 512 MB | Panasonic |
| V1.0, V1.1 | microSD 1 GB | Transcend, Panasonic |
| V2.0 SDHC CLASS 4 | microSD 4 GB | Panasonic |
| V2.0 SDHC CLASS 6 | microSD 4 GB | Transcend |
| V1.0, V1.1 | miniSD 128 MB | Transcend, Panasonic |
| V1.0, V1.1 | miniSD 256 MB | Transcend, Panasonic |
| V1.0, V1.1 | miniSD 512 MB | Transcend, Panasonic |
| V1.0, V1.1 | miniSD 1 GB | Transcend, Panasonic |
| V2.0 SDHC CLASS 4 | miniSD 4 GB | Transcend |
| V2.0 SDHC CLASS 6 | miniSD 4 GB | |
| <ul style="list-style-type: none"> - The DOS FAT file system is supported for the SD card. - Folders/files stored in the SD card should be in the 8.3 filename format - The miniSD/microSD card to SD card slot adapter is required. | | |

2.2.2 Interior view

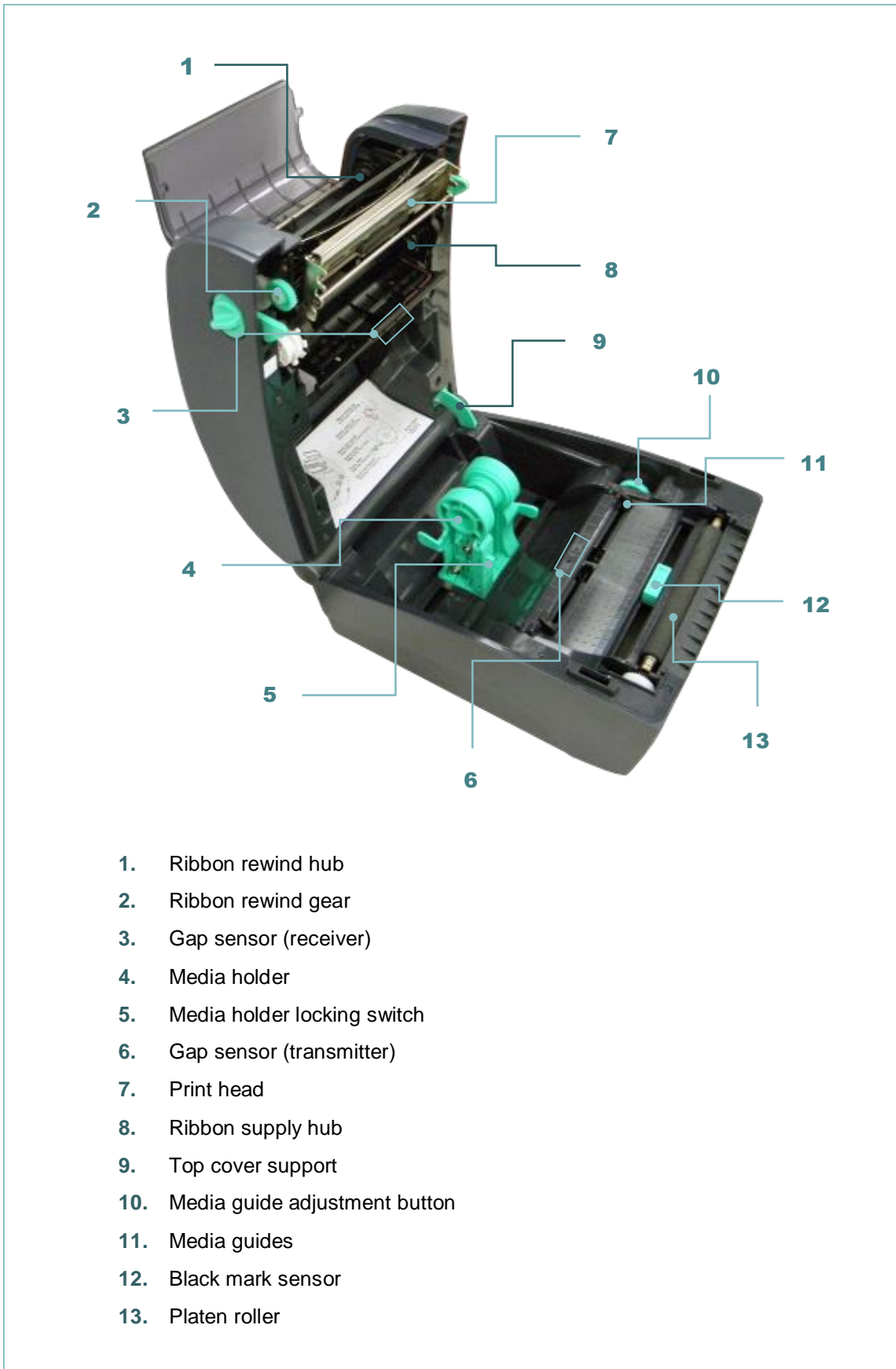

2.2.3 Rear View

For TC210 series

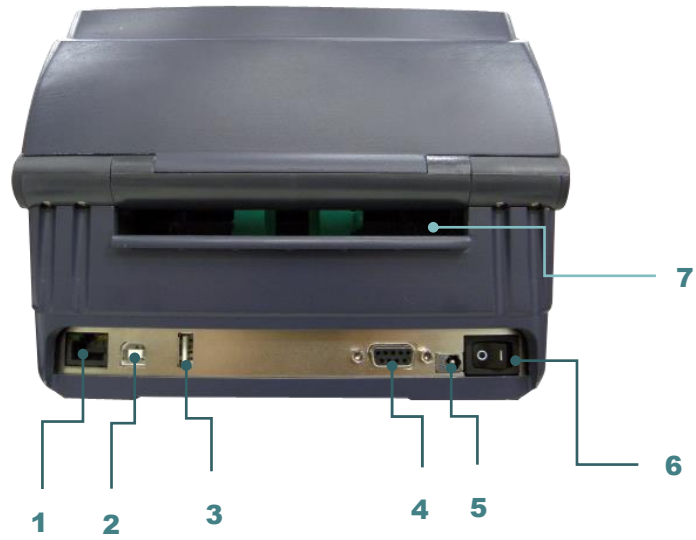

1. Ethernet interface
2. USB interface
3. USB host
4. RS-232C interface
5. Power jack socket
6. Power switch
7. External label entrance chute
8. Parallel interface

For TC200 series

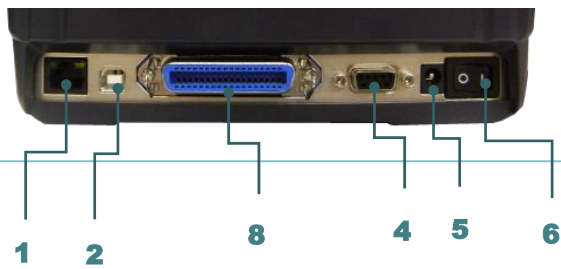

The interface picture here is for reference only. Please refer to the product specification for the interfaces availability.

2.3 Operator Control

2.3.1 LED Indication

This printer has one three-color LED indicator.

| LED Color | Description |
|--------------|--|
| Green/ Solid | This illuminates that the power is on and the device is ready to use. |
| Green/ Flash | This illuminates that the system is downloading data from PC to memory or the printer is paused. |
| Amber | This illuminates that the system is clearing data from printer. |
| Red / Solid | This illuminates printer head open, cutter error. |
| Red / Flash | This illuminates a printing error, such as head open, paper empty, paper jam, or memory error etc. |

2.3.2 Button Function

For TC200 series

- **Feed button**
 - When the printer is ready, press the button to feed one label to the beginning of next label
 - When the printer is printing, press the button to pause a print job. When the printer is paused the power LED will blink green. Press the button again to continue the printing job

For TC210series

- **Feed button**
 - When the printer is ready, press the button to feed one label to the beginning of next label
 - When the printer is printing, press the button to pause a print job. When the printer is paused the power LED will blink green. Press the button again to continue the printing job
 - When printer enter the menu, press the button to enter/select cursor located item
- **Menu button**
 - Enter the menu
 - Exit from a menu or cancel a setting and return to the previous menu
- **Navigation button**
 - Scroll the menu list

3. Setup

3.1 Setting up the printer

1. Place the printer on a flat, secure surface.
2. Make sure the power switch is off.
3. Connect the printer to the computer with the provided USB cable.
4. Plug the power cord into the AC power cord socket at the rear of the printer, and then plug the power cord into a properly grounded power outlet.

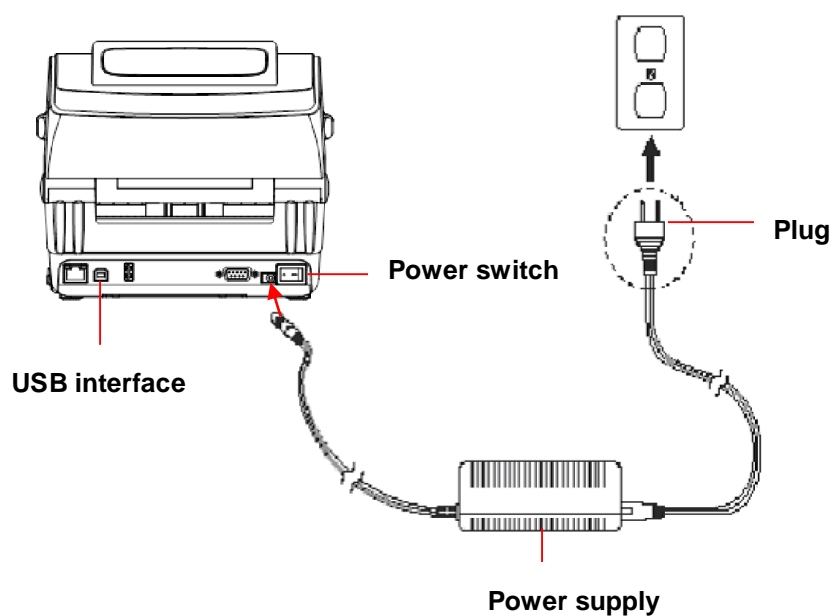

Note: Please switch OFF printer power switch prior to plug in the power cord to printer power jack.

3.2 Open/Close the Top Cover



1. Open the printer's top cover by pulling the top cover open levers located on each side of the printer and lifting the top cover to the maximum open angle.



2. A top cover support at the rear of the printer will engage with lower inner cover to hold the printer top cover open.



3. Hold the top cover and press the top cover support to disengage the top cover support with lower inner cover. Gently close the top cover.

3.3 Loading the Ribbon



1. Open the printer's top cover by pulling the top cover open levers located on each side of the printer and lifting the top cover to the maximum open angle.



2. Open the ribbon access cover and the media cover.

Note:

1. In normal printing mode, ribbon access cover can be opened while opens the top cover. Ribbon access cover can be closed while top cover is open or close.
2. In peeler and cutter mode, please open the top cover then the ribbon access cover can be opened or closed.



3. Insert the ribbon right side onto the supply hub. Align the notches on the left side and mount onto the spokes.

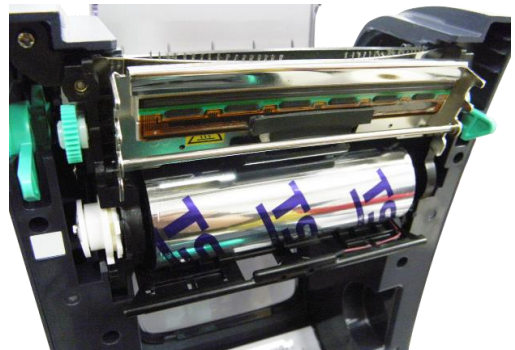

4. Insert the paper core right side onto the rewind hub. Align the notches on the left side and mount onto the spokes.

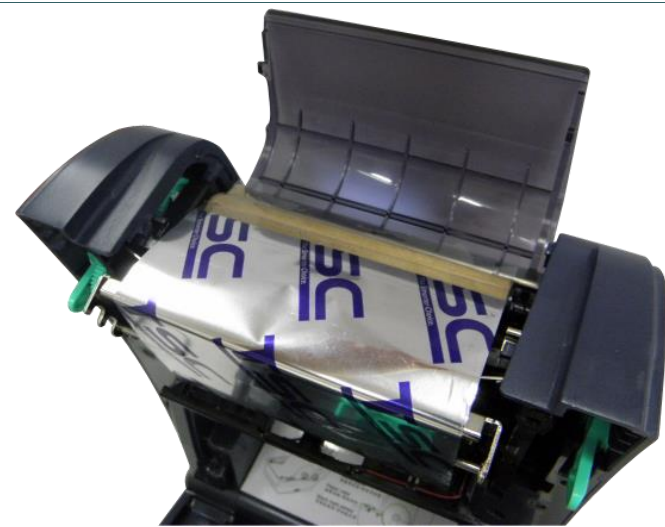
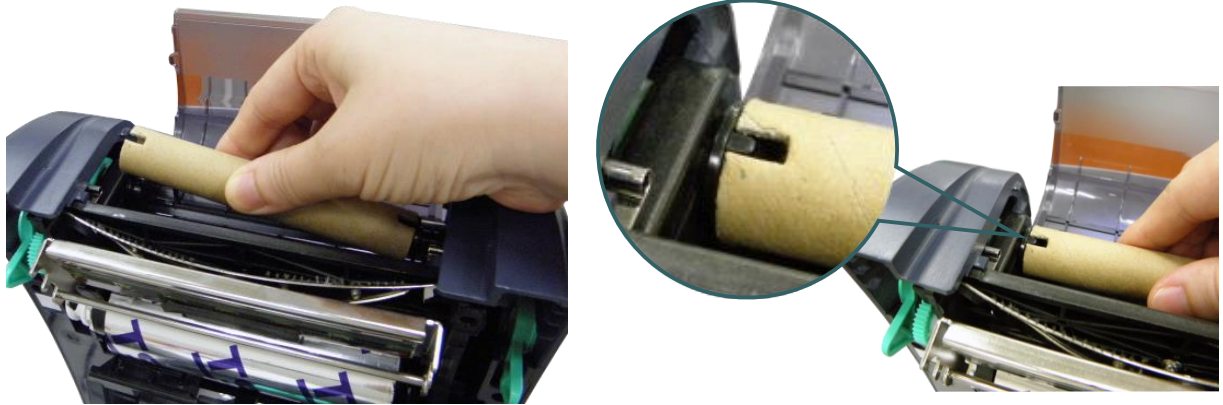

5. Stick the ribbon onto the ribbon rewind paper core.



6. Turn the ribbon rewind gear until the ribbon plastic leader is thoroughly wound and the black section of the ribbon covers the print head.



7. Close the ribbon access cover and the top cover.

Loading path for ribbon

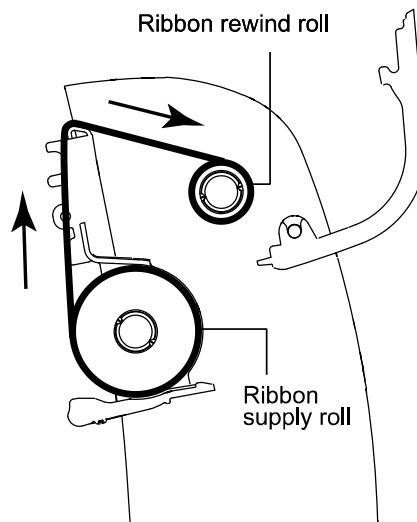

3.4 Loading the Media

3.4.1 Loading the Media



1. Open the printer top cover by pulling the tabs located on each side towards the front of the printer then lift the top cover to the maximum open angle.



2. Separate and hold open the media holders.



3. Place the roll between the holders and close them onto the core.



4. Press down the media holder lock switch to hold the label roll firmly.

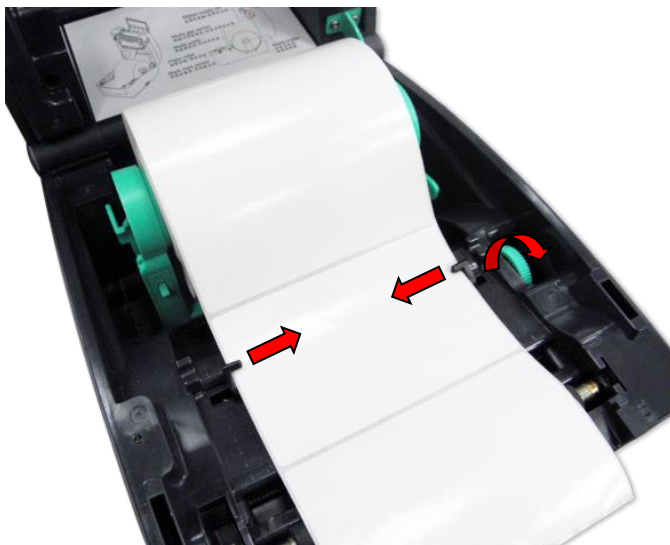

5. Place the paper, printing side face up, through the media sensor and place the label leading edge onto the platen roller. Move the media guides to fit the label width by turning the guide adjuster knob.



6. Disengage the top cover support and close the top cover gently.

-
7. Use “Diagnostic Tool” or LCD menu function to set the media sensor type and calibrate the selected sensor.

Note:

- Please calibrate the gap/black mark sensor when changing media.
- Please refer to the diagnostic utility quick start guide for more information. (Start the “Diagnostic tool” → Select the “Printer Configuration” tab → Click the “Calibrate Sensor” button)
- Please refer to the section 6 for LCD menu function.

Loading path for media

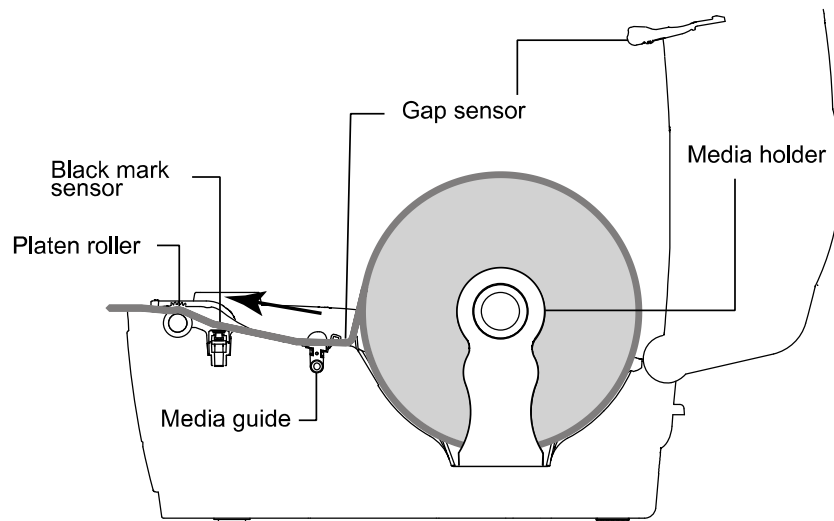

3.4.2 Loading the Fan-fold Media

1. Open the printer top cover then insert the fan-fold media through the external label entrance chute.



2. Separate and hold open the media holders.
Note: Press down the media holder lock switch to hold the media firmly.

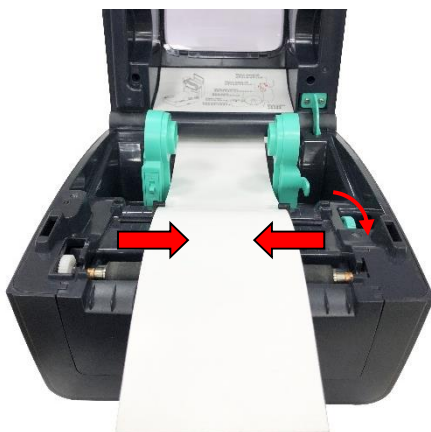
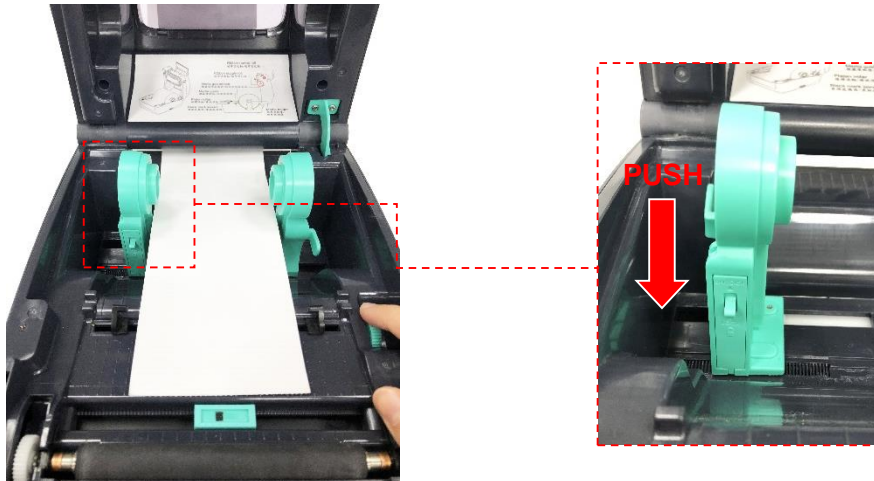

3. Place the paper, printing side face up, through the media sensor and place the media leading edge onto the platen roller. Move the media guides to fit the media width by turning the guide adjuster knob.



4. Complete the installation of fan-fold media.

3.4.3 External Label Roll Mount Installation (Option)

1. Attach an external paper roll mount on the bottom of the printer.



2. Insert a 3" label spindle into a paper roll. And install it on the external paper roll mount.

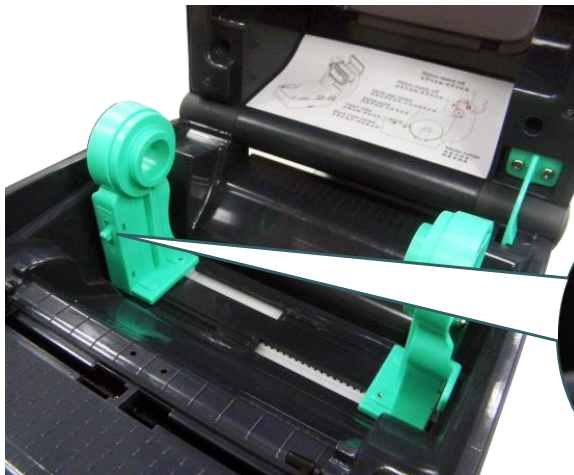

3. Open the printer's top cover and separate the media holders to fit the media width. Press down the media holder lock switch to fix the media holder.

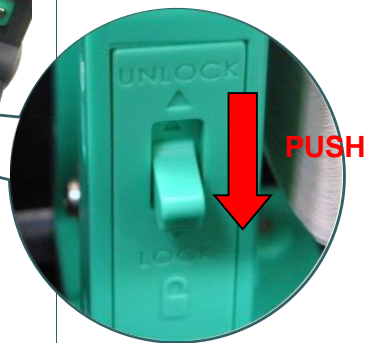

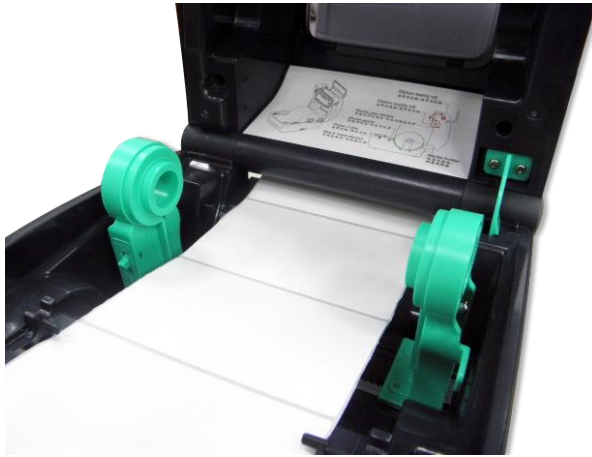

4. Feeds the media through the rear external label entrance chute. And place the paper, printing side face up, through the media sensor and place the label leading edge onto the platen roller. Move the media guides to fit the label width by turning the guide adjuster knob.

5. Disengage the top cover support and close the top cover gently.



6. Use "Diagnostic Tool" or LCD menu function to set the media sensor type and calibrate the selected sensor.

Note:

- Please calibrate the gap/black mark sensor when changing media.
 - Please refer to the diagnostic utility quick start guide for more information. (Start the "Diagnostic tool" → Select the "Printer Configuration" tab → Click the "Calibrate Sensor" button)
 - Please refer to the section 6 for LCD menu function.
-

3.4.4 Loading Media in Peel-off Mode (Option)

1. Please refer to section 3.3.1 to load the media.
2. Use “Diagnostic Tool” or LCD menu function to set the media sensor type and calibrate the selected sensor.

Note:

- Please calibrate the gap/black mark sensor before loading media in peel-off mode to avoid paper jam.
- Please calibrate the gap/black mark sensor when changing media.

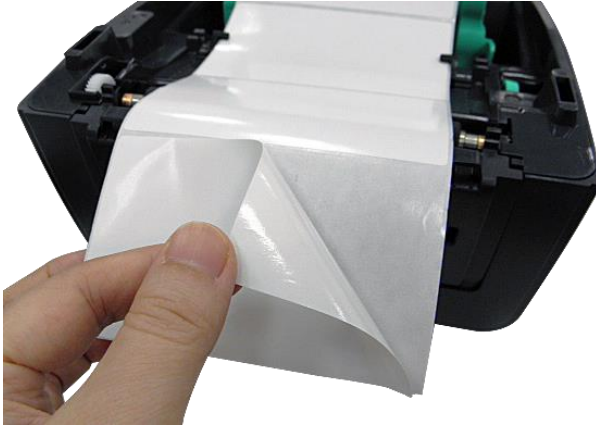

3. Open the printer cover. Pull the label through the front of the printer and take some labels off only leave the liner.



4. Open the peel-off module cover. Feed the liner into peel-off cover slot.



5. Close the peel-off module. Use the DiagTool or LCD menu function to enable the peel-off mode.

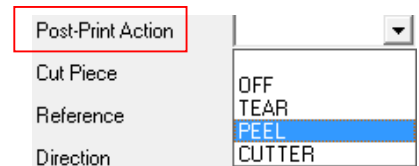



6. Disengage the top cover support to close the top cover. Printer is ready for peel-off mode.
7. Press the FEED button to test.

Note:
This peel-off module is supported for the thermal/ plain label only.

3.4.5 Loading Media in Cutter Mode (Option)

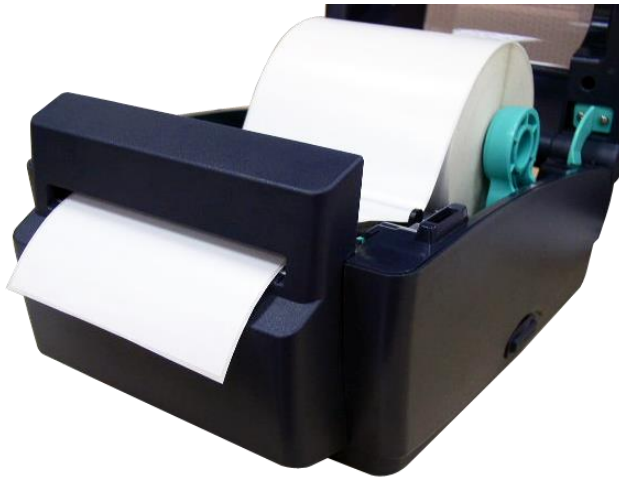

1. Please refer to section 3.3.1 to load the media.
2. Lead the media through the cutter paper opening.

3. Close the printer cover.
4. Use “Diagnostic Tool” or LCD menu function to set the media sensor type and calibrate the selected sensor.
5. Use the DiagTool or LCD menu function to enable the cutter mode.

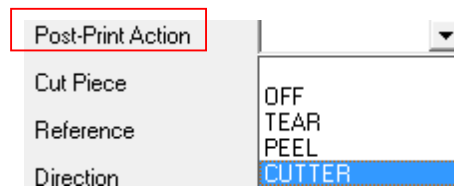

6. Press the FEED button to test.



Note:

Please calibrate the gap/black mark sensor when changing media.

4. Diagnostic Tool

TSC's Diagnostic Utility is an integrated tool incorporating features that enable you to explore a printer's settings/status; change a printer's settings; download graphics, fonts and firmware; create a printer bitmap font; and send additional commands to a printer. With the aid of this powerful tool, you can review printer status and setting in an instant, which makes it much easier to troubleshoot problems and other issues.

4.1 Start the Diagnostic Tool

1. Double click on the Diagnostic tool icon   to start the software.
2. There are four features (Printer Configuration, File Manager, Bitmap Font Manager, Command Tool) included in the Diagnostic utility.

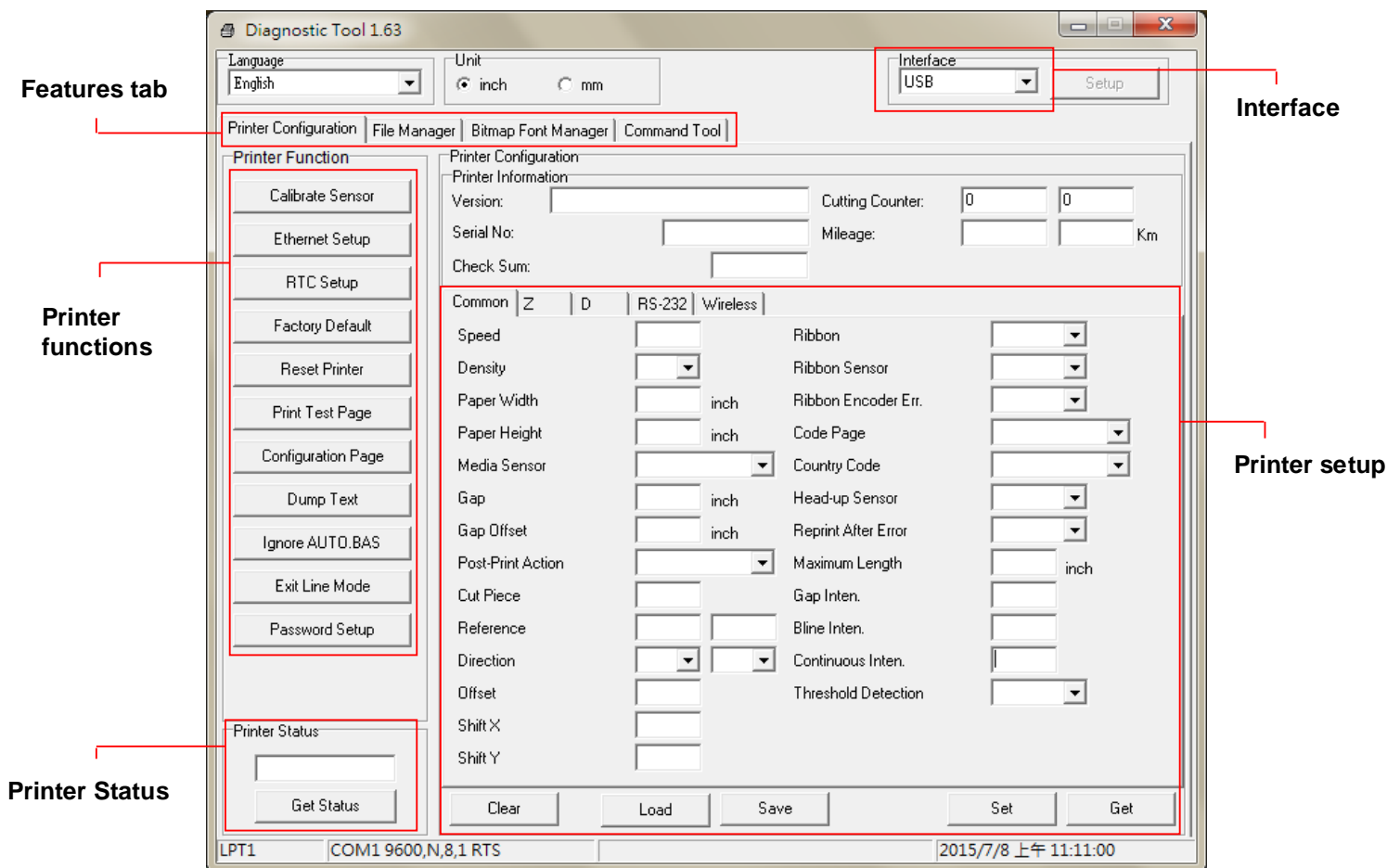

4.2 Printer Function

1. Connect the printer and computer with a cable.
2. Select the PC interface connected with bar code printer.

| USB cable | Other cable |
|--|---|
| Interface <input type="text" value="USB"/> <input type="button" value="Setup"/> <p>The default interface setting is USB interface. If USB interface is connected with printer, no other settings need to be changed in the interface field.</p> | Interface <input type="text" value="COM"/> <input type="button" value="Setup"/> 2 <input type="text" value="USB"/> <input type="text" value="COM"/> 1 <input type="text" value="LPT"/> <input type="text" value="ETHERNET"/> |

3. Click the “Printer Function” button to setup.
4. The detail functions in the Printer Function Group are listed as below.

| Printer Function | Function | Description |
|---|--------------------|--|
| <input type="button" value="Calibrate Sensor"/> | Calibrate Sensor | Calibrate the sensor specified in the Printer Setup group media sensor field |
| <input type="button" value="Ethernet Setup"/> | Ethernet Setup | Setup the IP address, subnet mask, gateway for the on board Ethernet |
| <input type="button" value="RTC Setup"/> | RTC Setup | Synchronize printer Real Time Clock with PC |
| <input type="button" value="Factory Default"/> | Factory Default | Initialize the printer and restore the settings to factory default. |
| <input type="button" value="Reset Printer"/> | Reset Printer | Reboot printer |
| <input type="button" value="Print Test Page"/> | Print Test Page | Print a test page |
| <input type="button" value="Configuration Page"/> | Configuration Page | Print printer configuration |
| <input type="button" value="Dump Text"/> | Dump Text | To activate the printer dump mode. |
| <input type="button" value="Ignore AUTO.BAS"/> | Ignore AUTO.BAS | Ignore the downloaded AUTO.BAS program |
| <input type="button" value="Exit Line Mode"/> | Exit Line Mode | Exit line mode. |
| <input type="button" value="Password Setup"/> | Password Setup | Set the password to protect the settings |

Note:

For more information about Diagnostic Tool, please refer to the diagnostic utility quick start guide in the CD disk \ Utilities directory.

4.3 Setting Ethernet by Diagnostic Tool

The Diagnostic Utility is enclosed in the CD disk \Utilities directory. Users can use Diagnostic Tool to setup the Ethernet by RS-232, USB and Ethernet interfaces. The following contents will instruct users how to configure the Ethernet by these three interfaces.

4.3.1 Using USB interface to setup Ethernet interface

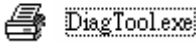
1. Connect the printer and computer with USB cable.
2. Turn on the printer power switch.
3. Start the Diagnostic Utility by double clicking on the  icon.
4. The Diagnostic Utility default interface setting is USB interface. If USB interface is connected with printer, no other settings need to be changed in the interface field.

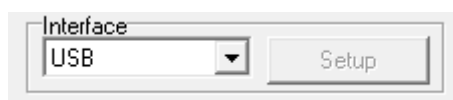

5. Click on the “Ethernet Setup” button from “Printer Function” group in Printer Configuration tab to setup the IP address, subnet mask and gateway for the on board Ethernet.

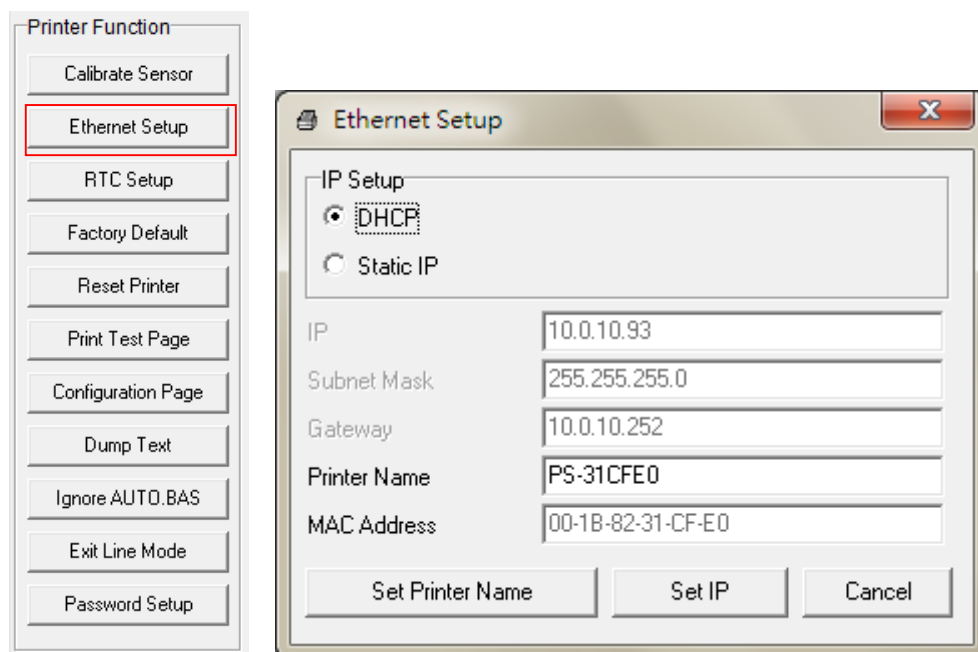

4.3.2 Using RS-232 interface to setup Ethernet interface

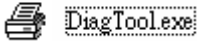
1. Connect the computer and the printer with a RS-232 cable.
2. Turn on the printer power.
3. Start the Diagnostic Utility by double clicks on the  icon.
4. Select “COM” as interface then click on the “Setup” button to setup the serial port baud rate, parity check, data bits, stop bit and flow control parameters.

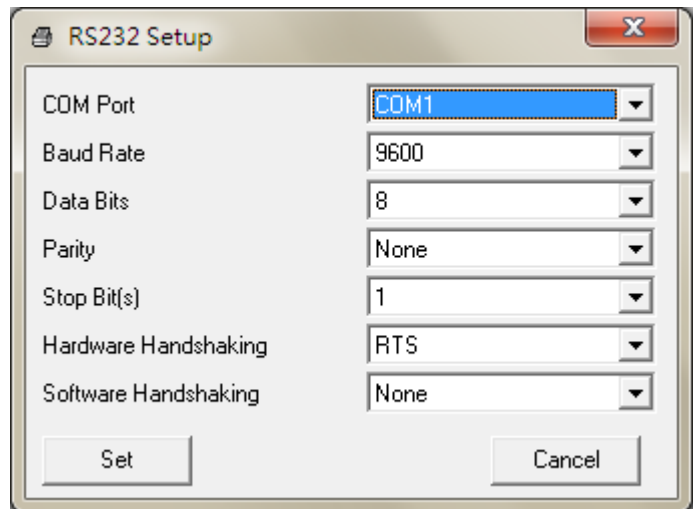
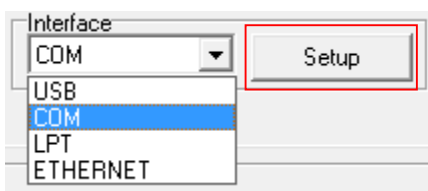

5. Click on the “Ethernet Setup” button from printer function of Printer Configuration tab to setup the IP address, subnet mask and the gateway for the on board Ethernet.

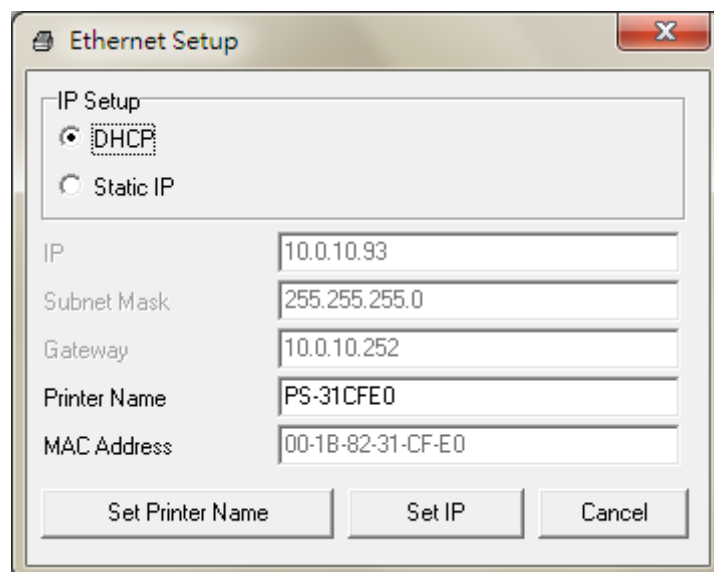

4.3.3 Using Ethernet interface to setup Ethernet interface

1. Connect the computer and the printer to the LAN.
2. Turn on the printer power.
3. Start the Diagnostic Utility by double clicks on the  `DiagTool.exe` icon.
4. Select “Ethernet” as the interface then click on the “Setup” button to setup the IP address, subnet mask and gateway for the on board Ethernet.

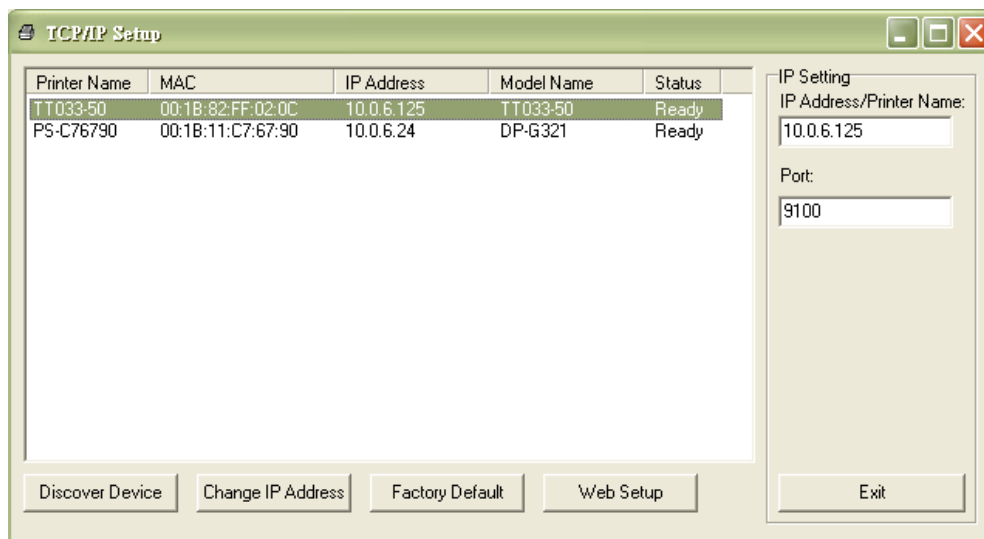
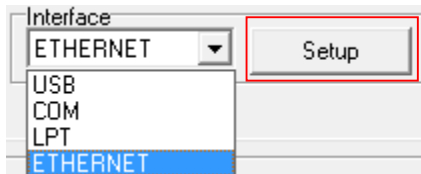

5. Click the “Discover Device” button to explore the printers that exist on the network.
6. Select the printer in the left side of listed printers, the correspondent IP address will be shown in the right side “IP address/Printer Name” field.
7. Click “Change IP Address” to configure the IP address obtained by DHCP or static.

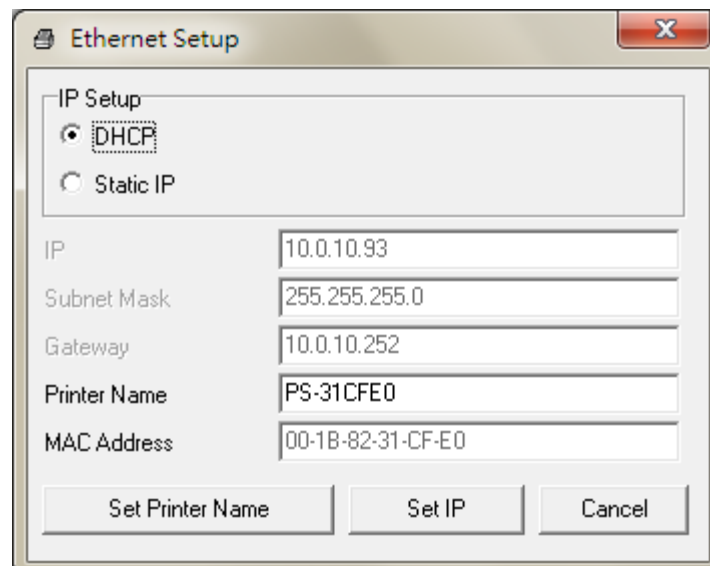

The default IP address is obtained by DHCP. To change the setting to static IP address, click “Static IP” radio button then enter the IP address, subnet mask and gateway. Click “Set IP” to take effect the settings.

Users can also change the “Printer Name” by another model name in this fields then click “Set Printer Name” to take effect this change.

Note: After clicking the “Set Printer Name” or “Set IP” button, printer will reset to take effect the settings.

8. Click “Exit” button to exit the Ethernet interface setup and go back to Diagnostic Tool main screen.

Factory Default button

This function will reset the IP, subnet mask, gateway parameters obtained by DHCP and reset the printer name.

Web setup button

Except to use the Diagnostic Utility to setup the printer, you can also explore and configure the printer settings and status or update the firmware with the IE or Firefox web browser. This feature provides a user friendly setup interface and the capability to manage the printer remotely over a network.

5. Power-on Utilities

There are six power-on utilities to set up and test printer hardware. These utilities are activated by pressing FEED button then turning on the printer power simultaneously and release the button at different status of LED.

Please follow the steps below for different power-on utilities.

1. Turn off the printer power switch.
2. Hold on the button then turn on the power switch.
3. Release the button when LED indicates with different status (color) for different functions.

| Power on utilities | The LED color will be changed as following pattern: | | | | | | | |
|--|--|-------|------------|------------|------------|-------------|------------|-------------|
| LED color | Green | Amber | Red | Amber | Green | Green/Amber | Red/Amber | Solid green |
| Functions | | | (5 blinks) | (5 blinks) | (5 blinks) | (5 blinks) | (5 blinks) | |
| Ribbon sensor calibration and gap / black mark sensor calibration | | | Release | | | | | |
| Gap / black mark sensor calibration, Self-test and enter dump mode | | | | Release | | | | |
| Printer initialization | | | | | Release | | | |
| Set black mark sensor as media sensor and calibrate the black mark sensor | | | | | | Release | | |
| Set gap sensor as media sensor and calibrate the gap sensor | | | | | | | Release | |
| Skip AUTO.BAS | | | | | | | | Release |

5.1 Ribbon and Gap/Black Mark Sensor Calibration

Gap/black mark sensor sensitivity should be calibrated at the following conditions:

1. A brand new printer
2. Change label stock
3. Printer initialization

Please follow the steps below to calibrate the ribbon and gap/black mark sensor.

1. Turn off the power switch.
2. Hold on the button then turn on the power switch.
3. Release the button when LED becomes **red** and blinking. (Any red will do during the 5 blinks)

- It will calibrate the ribbon sensor and gap/black mark sensor sensitivity.
- The LED color will be changed as following order :
Green → amber → **red (5 blinks)** → amber (5 blinks) → green (5 blinks) → green/amber (5 blinks) → red/amber (5 blinks) → solid green

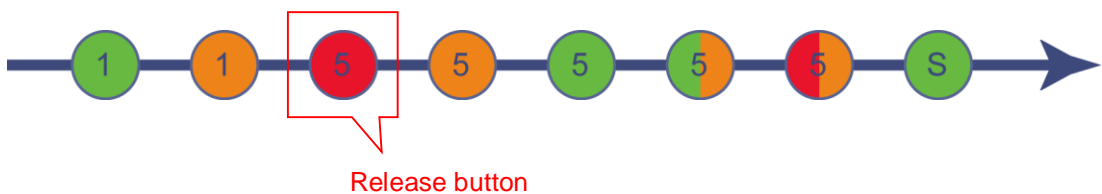

Note:

Please select gap or black mark sensor by sending GAP or BLINE command to printer prior to calibrate the sensor.

For more information about GAP and BLINE command, please refer to TSPL2 programming manual.

5.2 Gap/Black Mark Calibration, Self-test and Dump Mode

While calibrate the gap/black mark sensor, printer will measure the label length, print the internal configuration (self-test) on label and then enter the dump mode. To calibrate gap or black mark sensor, depends on the sensor setting in the last print job.

Please follow the steps below to calibrate the sensor.

1. Turn off the power switch.
2. Hold on the button then turn on the power switch.
3. Release the button when LED becomes **amber** and blinking. (Any amber will do during the 5 blinks)
 - The LED will be changed as following order.
Green → amber → red (5 blinks) → **amber (5 blinks)** → green (5 blinks) → green/amber (5 blinks)
→ red/amber (5 blinks) → solid green

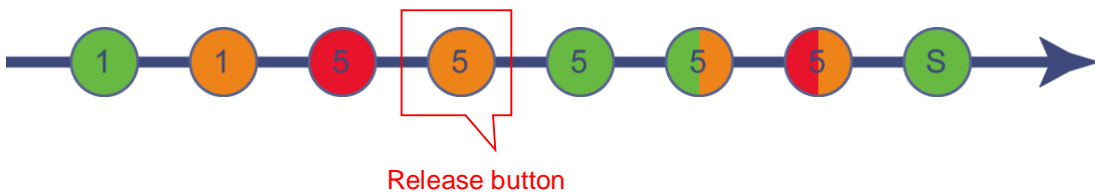

4. It calibrates the sensor and measures the label length and prints internal settings then enter the dump mode.

Note:

Please select gap or black mark sensor by Diagnostic Tool or by GAP or BLINE command prior to calibrate the sensor.

For more information about GAP and BLINE command, please refer to TSPL2 programming manual.

■ Self-test

Printer will print the printer configuration after gap/black mark sensor calibration. Self-test printout can be used to check if there is any dot damage on the heater element, printer configurations and available memory space.

| Self-test printout | |
|--|---------------------------------|
| <p>----- SYSTEM INFORMATION -----</p> | |
| MODEL : XXXXXX | Model name |
| FIRMWARE : X.XX | F/W version |
| CHECKSUM : XXXXXXXX | Firmware checksum |
| S/N : XXXXXXXXXXXX | Printer S/N |
| TCF : NO | Configuration file |
| DATE : 1970/01/01 | System date |
| TIME : 00:04:18 | System time |
| NON-RESET : 110 m (TPH) | Printed mileage (meter) |
| RESET : 110 m (TPH) | |
| NON-RESET : 0 (CUT) | Cutting counter |
| RESET : 0 (CUT) | |
| ----- | |
| <p>----- PRINTING SETTING -----</p> | |
| SPEED : 5 IPS | Print speed (inch/sec) |
| DENSITY : 8.0 | Print darkness |
| WIDTH : 4.00 INCH | Label size (inch) |
| HEIGHT : 4.00 INCH | Gap distance (inch) |
| GAP : 0.00 INCH | Gap/black mark sensor intension |
| INTENSION : 5 | Code page |
| CODEPAGE : 850 | Country code |
| COUNTRY : 001 | |
| ----- | |
| <p>----- Z SETTING -----</p> | |
| DARKNESS : 16.0 | ZPL setting information |
| SPEED : 4 IPS | Print darkness |
| WIDTH : 4.00 INCH | Print speed (inch/sec) |
| TILDE : 7EH (~) | Label size |
| CARET : 5EH (^) | Control prefix |
| DELIMITER : 2CH (,) | Format prefix |
| POWER UP : NO MOTION | Delimiter prefix |
| HEAD CLOSE : NO MOTION | Printer power up motion |
| | Printer head close motion |
| ----- | |
| <p>----- RS232 SETTING -----</p> | |
| BAUD : 9600 | RS232 serial port configuration |
| PARITY : NONE | |
| DATA BIT : 8 | |
| STOP BIT : 1 | |
| ----- | |

Note:
 ZPL is emulating for Zebra® language.

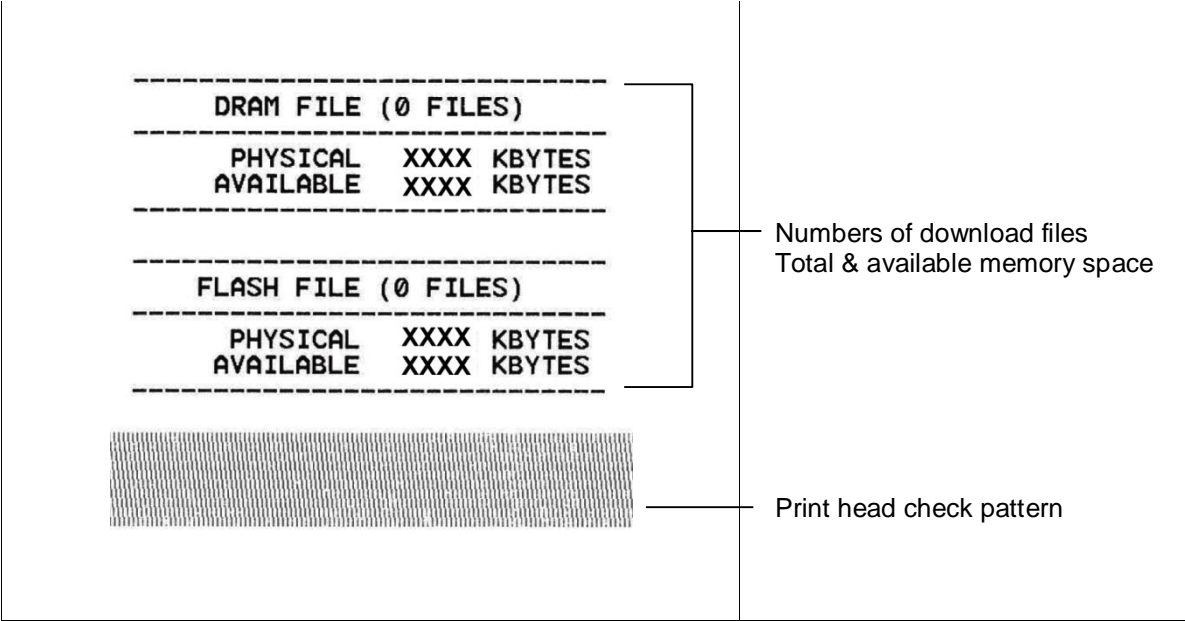

■ Dump mode

Printer will enter dump mode after printing printer configuration. In the dump mode, all characters will be printed in 2 columns as following. The left side characters are received from your system and right side data are the corresponding hexadecimal value of the characters. It allows users or engineers to verify and debug the program.

| | | | | |
|------------|---|--|---|---|
| ASCII Data | → | <pre> SPEED 2.0 53 50 45 45 44 20 32 2E 30 0D DENSITY 8 0A 44 45 4E 53 49 54 59 20 38 SET PEEL 0D 0A 53 45 54 20 50 45 45 4C OFF DIRE 20 4F 46 46 0D 0A 44 49 52 45 CTION 0 0 43 54 49 4F 4E 20 30 0D 0A 47 AP 3.00 mm 41 50 20 33 2E 30 30 20 6D 6D .0 00 mm 2C 30 2E 30 30 20 6D 6D 0D 0A REFERENCE 52 45 46 45 52 45 4E 43 45 20 0.0 SET C 30 2C 30 0D 0A 53 45 54 20 43 UTTER OFF 55 54 54 45 52 20 4F 46 46 0D SIZE 100. 0A 53 49 5A 45 20 31 30 30 2E 02 mm.65.0 30 32 20 6D 6D 2C 36 35 2E 30 4 mm CLS 34 20 6D 6D 0D 0A 43 4C 53 0D BARCODE 1 0A 42 41 52 43 4F 44 45 20 31 44.149.39 34 34 2C 31 34 39 2C 22 33 39 .120.1.0. 22 2C 31 32 30 2C 31 2C 30 2C 2.6.57114 32 2C 36 2C 22 35 37 31 31 34 38T* PRIN 33 38 54 22 0D 0A 50 52 49 4E T 1.1 SPE 54 20 31 2C 31 0D 0A 53 50 45 ED 2.0 DE 45 44 20 32 2E 30 0D 0A 44 45 NSITY 8 S 4E 53 49 64 59 20 38 0D 0A 53 ET PEEL OF 45 54 20 50 45 45 4C 20 4F 46 F DIRECTI 46 0D 0A 44 49 52 45 43 54 49 ON 0 GAP 4F 4E 20 30 0D 0A 47 41 50 20 3.00 mm.0. 33 2E 30 30 20 6D 6D 2C 30 2E 00 mm REF 30 30 20 6D 6D 0D 0A 52 45 46 ERENCE 0.0 45 52 45 4E 43 45 20 30 2C 30 SET CUTT 0D 0A 53 45 54 20 43 55 54 54 ER OFF SI 45 52 20 4F 46 46 0D 0A 53 49 ZE 100.02 5A 45 20 31 30 30 2E 30 32 20 mm.65.04 m 6D 6D 2C 36 35 2E 30 34 20 6D m CLS BA 6D 0D 0A 43 4C 53 0D 0A 42 41 RCODE 144. 52 43 4F 44 45 20 31 34 34 2C 149.39.1 31 34 39 2C 22 33 39 22 2C 31 20.1.0.2.6 32 30 2C 31 2C 30 2C 32 2C 36 .5711438T 2C 22 35 37 31 31 34 33 38 54 * PRINT 1 22 0D 0A 50 52 49 4E 54 20 31 .1 2C 31 0D 0A </pre> | ← | Hex decimal data related to left column of ASCII data |
|------------|---|--|---|---|

Note:

1. Dump mode requires 4" wide paper width.
2. Turn off / on the power to resume printer for normal printing.

5.3 Printer Initialization

Printer initialization is used to clear DRAM and restore printer settings to defaults. The only one exception is ribbon sensitivity, which will not be restored to default.

Printer initialization is activated by the following procedures.

1. Turn off the power switch.
2. Hold on the button then turn on the power switch.
3. Release the button when LED turns **green** after 5 amber blinks. (Any green will do during the 5 blinks)
 - The LED will be changed as following:
 Green → amber → red (5 blinks) → amber (5 blinks) → **green (5 blinks)** → green/amber (5 blinks)
 → red/amber (5 blinks) → solid green



Printer configuration will be restored to defaults as below after initialization.

| Parameter | Default setting |
|----------------------|---|
| Speed | 127 mm/sec (5 ips) (203DPI) 76 mm/sec (3 ips) (300DPI) |
| Density | 8 |
| Label Width | 4" (101.5 mm) |
| Label Height | 4" (101.5 mm) |
| Sensor Type | Gap sensor |
| Gap Setting | 0.12" (3.0 mm) |
| Print Direction | 0 |
| Reference Point | 0,0 (upper left corner) |
| Offset | 0 |
| Tear Mode | On |
| Peel off Mode | Off |
| Cutter Mode | Off |
| Serial Port Settings | 9600 bps, none parity, 8 data bits, 1 stop bit |
| Code Page | 850 |
| Country Code | 001 |
| Clear Flash Memory | No |
| IP Address | DHCP |

5.4 Set Black Mark Sensor as Media Sensor and Calibrate the Black Mark Sensor

Please follow the steps as below.

1. Turn off the power switch.
2. Hold on the button then turn on the power switch.
3. Release the button when LED turns **green/amber** after 5 green blinks. (Any green/amber will do during the 5 blinks).

- The LED will be changed as following:

Green → amber → red (5 blinks) → amber (5 blinks) → green (5 blinks) → **green/amber (5 blinks)**
→ red/amber (5 blinks) → solid green

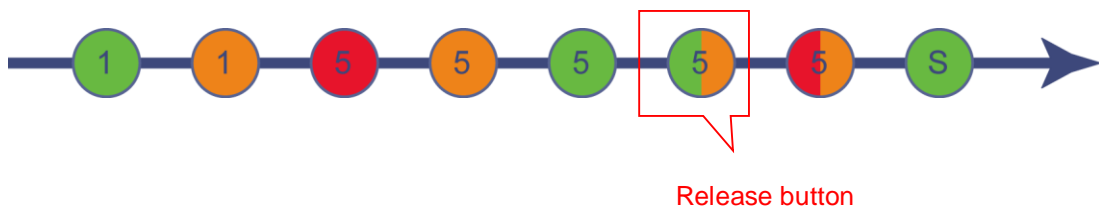

5.5 Set Gap Sensor as Media Sensor and Calibrate the Gap Sensor

Please follow the steps as below.

1. Turn off the power switch.
 2. Hold on the button then turn on the power switch.
 3. Release the button when LED turns **red/amber** after 5 green/amber blinks. (Any red/amber will do during the 5 blinks).
- The LED will be changed as following:
Green → amber → red (5 blinks) → amber (5 blinks) → green (5 blinks) → green/amber (5 blinks) → **red/amber (5 blinks)** → solid green

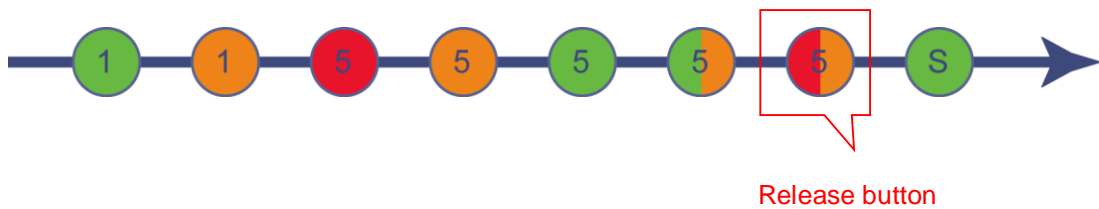

5.6 Skip AUTO.BAS

TSPL2 programming language allows user to download an auto execution file to flash memory. Printer will run the AUTO.BAS program immediately when turning on printer power. The AUTO.BAS program can be interrupted without running the program by the power-on utility.

Please follow the procedures below to skip an AUTO.BAS program.

1. Turn off printer power.
2. Press the FEED button and then turn on power.
3. Release the FEED button when LED becomes **solid green**.

- The LED will be changed as following:

Green → amber → red (5 blinks) → amber (5 blinks) → green (5 blinks) → green/amber (5 blinks) → red/amber (5 blinks) → **solid green**

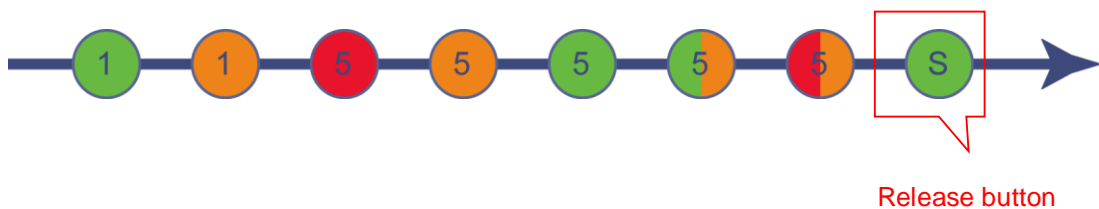

4. Printer will be interrupted to run the AUTO.BAS program.

6. LCD Menu Function

6.1 Enter the Menu

Press the “Menu” button to enter the main menu. Use the “Cross” button to select the item on main menu. The selected item will turn red. Press the “Feed” button to enter the setting list.

Note: This LCD function is for TC210/310 series.

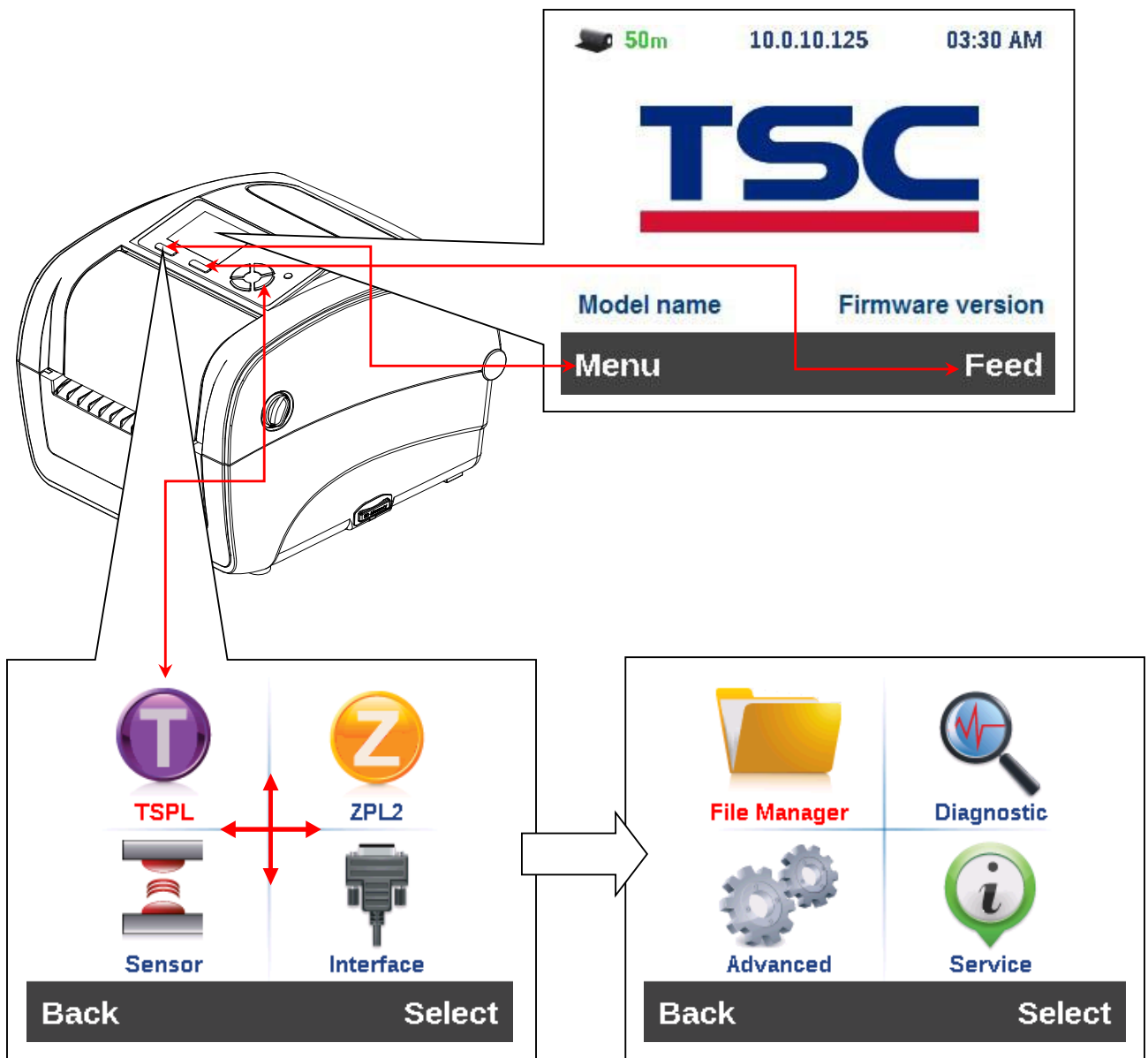

6.2 Main Menu Overview

There are 8 categories for the main menu. You can easily set the settings of printer without connecting the computer. Please refer to following sections for more details.

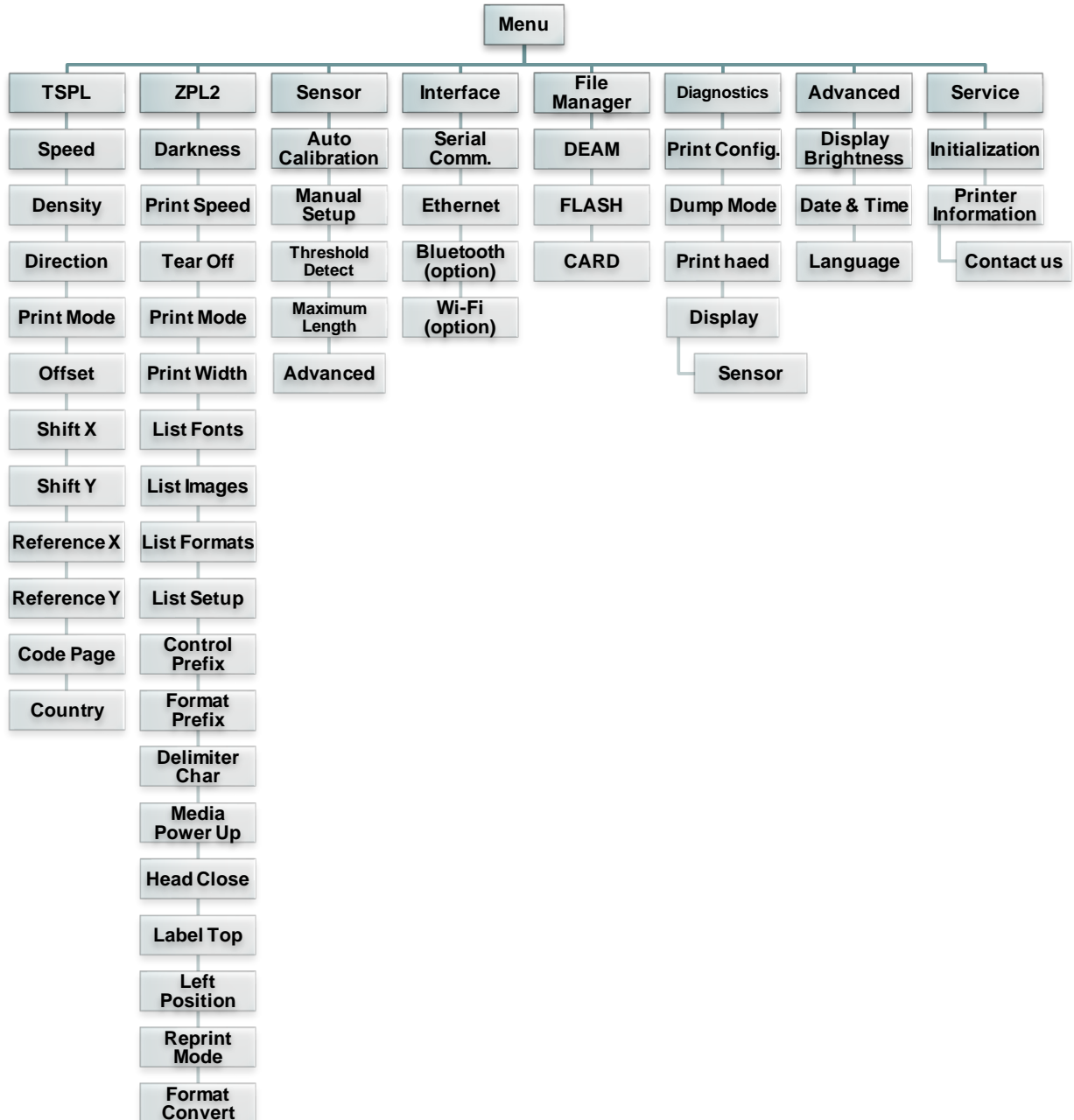

6.3 TSPL2

This “TSPL2” category can set up the printer settings for TSPL2.

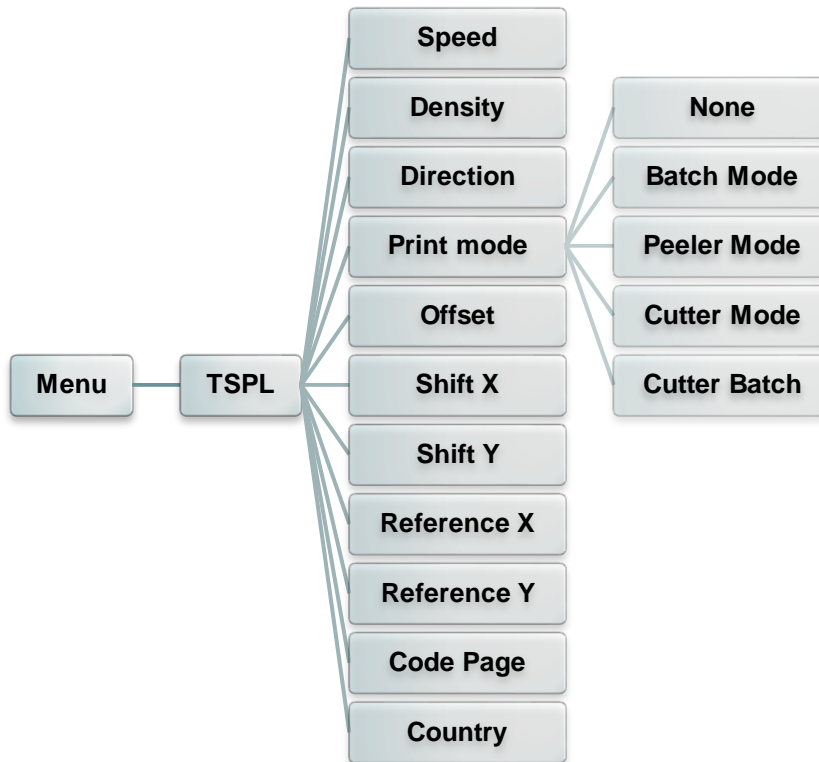

| Item | Description | Default | | | | |
|-------------------|---|--------------|-------------|------|---|-------------------|
| Speed | Use this item to setup print speed. | N/A | | | | |
| Density | Use this option to setup printing darkness. The available setting is from 0 to 15, and the step is 1. You may need to adjust your density based on selected media. | 8 | | | | |
| Direction | <p>The direction setting value is either 1 or 0. Use this item to setup the printout direction.</p> | 0 | | | | |
| Print mode | <p>This item is used to set the print mode. There are 5 modes as below,</p> <table border="1"> <thead> <tr> <th>Printer Mode</th> <th>Description</th> </tr> </thead> <tbody> <tr> <td>None</td> <td>Next label top of form is aligned to the print head burn line location. (Tear Off Mode)</td> </tr> </tbody> </table> | Printer Mode | Description | None | Next label top of form is aligned to the print head burn line location. (Tear Off Mode) | Batch Mode |
| Printer Mode | Description | | | | | |
| None | Next label top of form is aligned to the print head burn line location. (Tear Off Mode) | | | | | |

| | | | |
|--------------------|---|--|-------------|
| | Batch Mode | Once image is printed completely, label gap/black mark will be fed to the tear plate location for tear away. | |
| | Peeler Mode | Enable the label peel off mode. | |
| | Cutter Mode | Enable the label cutter mode. | |
| | Cutter Batch | Cut the label once at the end of the printing job. | |
| Offset | This item is used to fine tune media stop location. Available setting value is from "+" to "-" or "0" to "9". | | +000 |
| Shift X | This item is used to fine tune print position. Available setting value is from "+" to "-" or "0" to "9". | | +000 |
| Shift Y | | | +000 |
| Reference X | This item is used to set the origin of printer coordinate system horizontally and vertically. Available setting value is from "0" to "9". | | 000 |
| Reference Y | | | 000 |
| Code page | Use this item to set the code page of international character set. | | 850 |
| Country | Use this option to set the country code. | | 001 |

Note: If printing from enclosed software/driver, the software/driver will send out the commands, which will overwrite the settings set from the panel.

6.4 ZPL2

This “ZPL2” category can set up the printer settings for ZPL2.

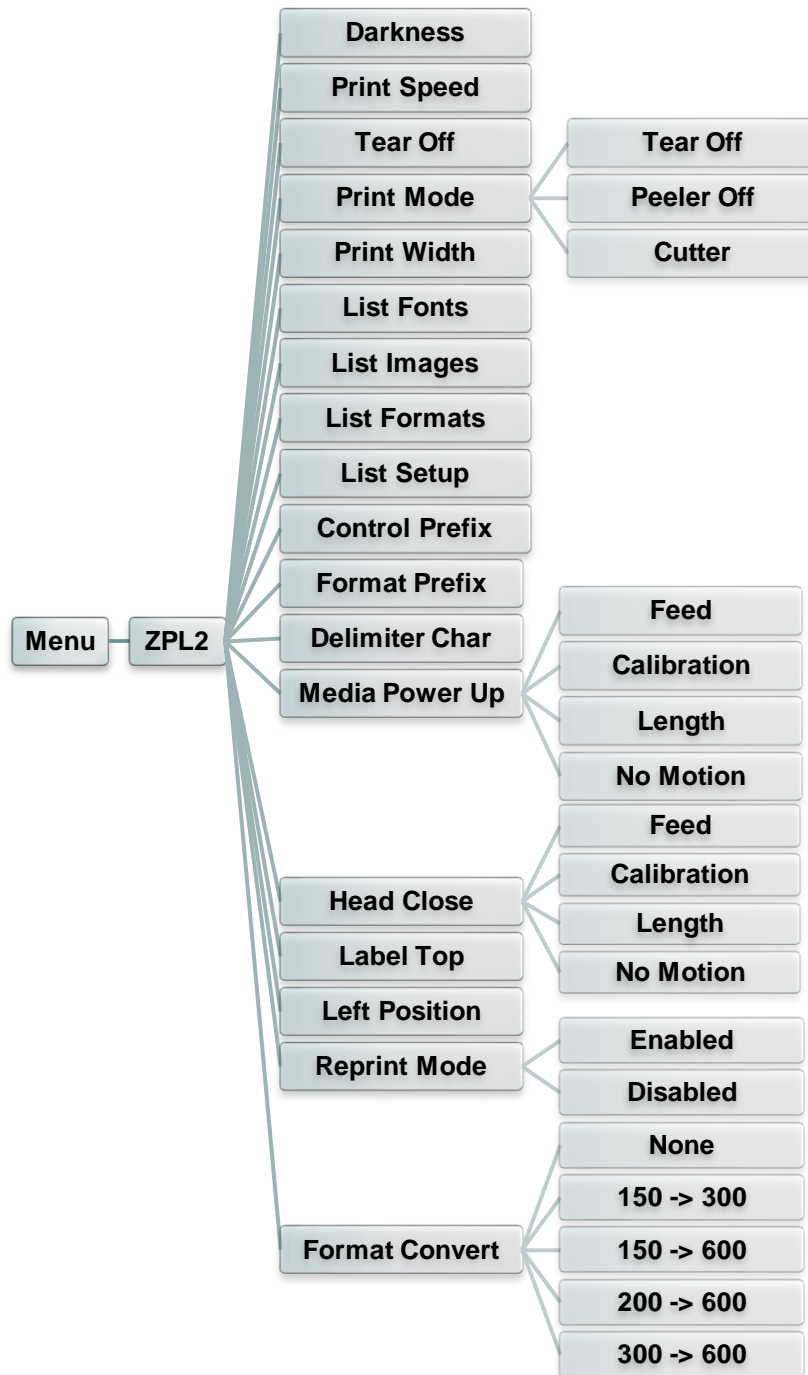

| Item | Description | Default |
|-----------------|--|-----------|
| Darkness | Use this item to setup printing darkness. The available setting is from 0 to 30, and the step is 1. You may need to adjust your density based on selected media. | 16 |

| Print Speed | Use this item to setup print speed. The each increase or decrease is 1 ips. Available setting is from 2 to 6. | 6 (203dpi) 4 (300dpi) 3 (600dpi) | | | | | | | | | | |
|-----------------------|---|--|-------------|----------|---|-------------|---|--------|---|-----------------|-----------------------------|------------------|
| Tear Off | This item is used to fine tune media stop location. Available setting value is from “+” to “-” or “0” to “9”. | +000 | | | | | | | | | | |
| Print mode | <p>This item is used to set the print mode. There are 3 modes as below,</p> <table border="1"> <thead> <tr> <th>Printer Mode</th> <th>Description</th> </tr> </thead> <tbody> <tr> <td>Tear Off</td> <td>Next label top of form is aligned to the print head burn line location.</td> </tr> <tr> <td>Peeler Off</td> <td>Enable the label peel off mode.</td> </tr> <tr> <td>Cutter</td> <td>Enable the label cutter mode</td> </tr> </tbody> </table> | Printer Mode | Description | Tear Off | Next label top of form is aligned to the print head burn line location. | Peeler Off | Enable the label peel off mode. | Cutter | Enable the label cutter mode | Tear Off | | |
| Printer Mode | Description | | | | | | | | | | | |
| Tear Off | Next label top of form is aligned to the print head burn line location. | | | | | | | | | | | |
| Peeler Off | Enable the label peel off mode. | | | | | | | | | | | |
| Cutter | Enable the label cutter mode | | | | | | | | | | | |
| Print Width | This item is used to set print width. The available value is from “0” to “9”. | N/A | | | | | | | | | | |
| List Fonts | This feature is used to print current printer available fonts list to the label. The fonts stored in the printer’s DRAM, Flash or optional memory card. | N/A | | | | | | | | | | |
| List Images | This feature is used to print current printer available images list to the label. The images stored in the printer’s DRAM, Flash or optional memory card. | N/A | | | | | | | | | | |
| List Formats | This feature is used to print current printer available formats list to the label. The formats stored in the printer’s DRAM, Flash or optional memory card. | N/A | | | | | | | | | | |
| List Setup | This feature is used to print current printer configuration to the label. | N/A | | | | | | | | | | |
| Control Prefix | This feature is used to set control prefix character. | N/A | | | | | | | | | | |
| Format Prefix | This feature is used to set format prefix character. | N/A | | | | | | | | | | |
| Delimiter Char | This feature is used to set delimiter character. | N/A | | | | | | | | | | |
| Media Power Up | <p>This option is used to set the action of the media when you turn on the printer.</p> <table border="1"> <thead> <tr> <th>Selections</th> <th>Description</th> </tr> </thead> <tbody> <tr> <td>Feed</td> <td>Printer will advance one label</td> </tr> <tr> <td>Calibration</td> <td>Printer will calibration the sensor levels, determine length and feed label</td> </tr> <tr> <td>Length</td> <td>Printer determine length and feed label</td> </tr> <tr> <td>No Motion</td> <td>Printer will not move media</td> </tr> </tbody> </table> | Selections | Description | Feed | Printer will advance one label | Calibration | Printer will calibration the sensor levels, determine length and feed label | Length | Printer determine length and feed label | No Motion | Printer will not move media | No Motion |
| Selections | Description | | | | | | | | | | | |
| Feed | Printer will advance one label | | | | | | | | | | | |
| Calibration | Printer will calibration the sensor levels, determine length and feed label | | | | | | | | | | | |
| Length | Printer determine length and feed label | | | | | | | | | | | |
| No Motion | Printer will not move media | | | | | | | | | | | |
| Head Close | <p>This option is used to set the action of the media when you close the print head.</p> <table border="1"> <thead> <tr> <th>Selections</th> <th>Description</th> </tr> </thead> <tbody> <tr> <td>Feed</td> <td>Printer will advance one label</td> </tr> <tr> <td>Calibration</td> <td>Printer will calibration the sensor levels, determine length and feed label</td> </tr> <tr> <td>Length</td> <td>Printer determine length and feed label</td> </tr> <tr> <td>No Motion</td> <td>Printer will not move media</td> </tr> </tbody> </table> | Selections | Description | Feed | Printer will advance one label | Calibration | Printer will calibration the sensor levels, determine length and feed label | Length | Printer determine length and feed label | No Motion | Printer will not move media | No Motion |
| Selections | Description | | | | | | | | | | | |
| Feed | Printer will advance one label | | | | | | | | | | | |
| Calibration | Printer will calibration the sensor levels, determine length and feed label | | | | | | | | | | | |
| Length | Printer determine length and feed label | | | | | | | | | | | |
| No Motion | Printer will not move media | | | | | | | | | | | |
| Label Top | This option is used to adjust print position vertically on the label. The range is -120 to +120 dots. | 0 | | | | | | | | | | |

| | | |
|-----------------------|--|-----------------|
| Left Position | This option is used to adjust print position horizontally on the label. The range is -9999 to +9999 dots. | +0000 |
| Reprint Mode | When reprint mode is enabled, you can reprint the last label printer by pressing "UP" button on printer's control panel. | Disabled |
| Format Convert | Selects the bitmap scaling factor. The first number is the original dots per inch (dpi) value; the second, the dpi to which you would like to scale. | None |

Note: If printing from enclosed software/driver, the software/driver will send out the commands, which will overwrite the settings set from the panel.

6.5 Sensor

This option is used to calibrate the selected sensor. We recommend calibrate the sensor before printing when changing the media.

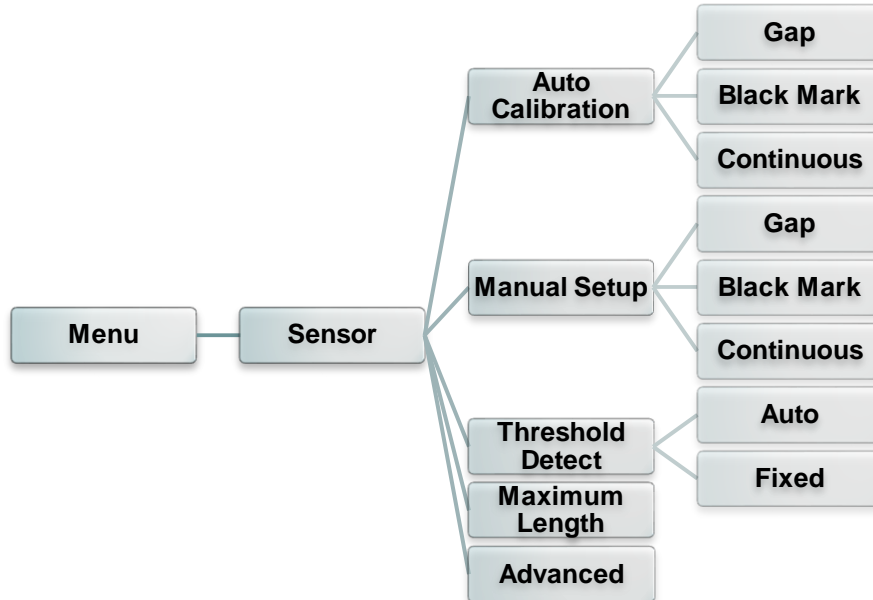

| Item | Description | Default |
|-------------------------|---|--------------|
| Auto Calibration | Printer will feed 2 to 3 gap labels to calibrate the sensor sensitivity automatically. | N/A |
| Manual Setup | In case “Auto calibration” cannot apply to the media, please use “Manual setup” function to calibrate the sensor sensitivity. | N/A |
| Threshold Detect | This option is used to set sensor sensitivity in fixed or auto. | Auto |
| Maximum Length | This option is used to set the maximum length for label calibration. | 254mm |
| Advanced | This function can set the minimum paper length and maximum gap/bline length for auto-calibrate the sensor sensitivity. | OFF |

6.6 Interface

This option is used to set the printer interface settings.

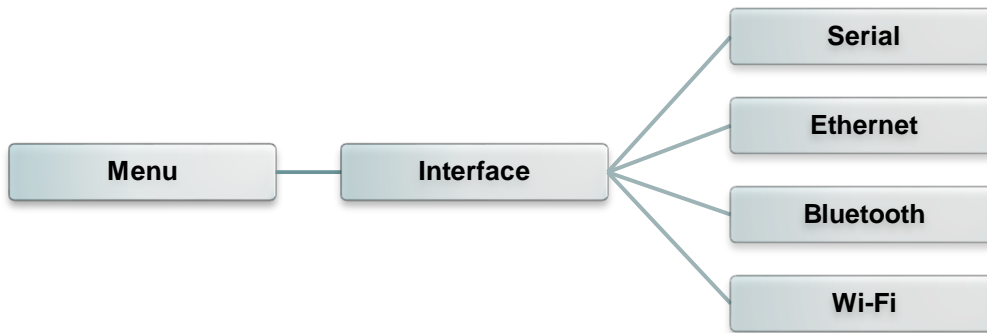

6.6.1 Serial Comm.

This option is used to set the printer RS-232 settings.

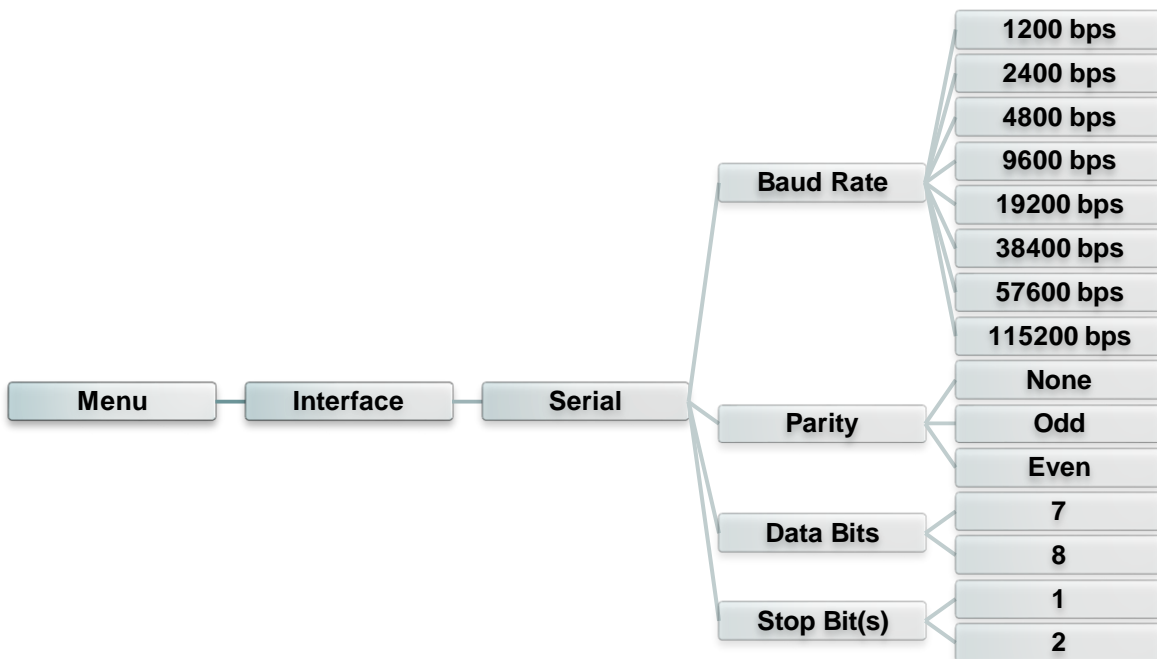

| Item | Description | Default |
|--------------------|--|-------------|
| Baud Rate | This item is used to set the RS-232 baud rate. | 9600 |
| Parity | This item is used to set the RS-232 parity. | None |
| Data Bits | This item is used to set the RS-232 Data Bits. | 8 |
| Stop Bit(s) | This item is used to set the RS-232 Stop Bits. | 1 |

6.6.2 Ethernet

Use this menu to configure internal Ethernet configuration check the printer's Ethernet module status, and reset the Ethernet module.

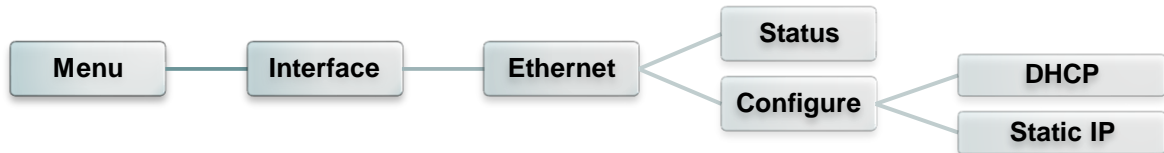

| Item | Description | Default |
|------------------|---|------------|
| Status | Use this menu to check the Ethernet IP address and MAC setting status. | N/A |
| DHCP | This item is used to ON or OFF the DHCP (Dynamic Host Configuration Protocol) network protocol. | N/A |
| Static IP | Use this menu to set the printer's IP address, subnet mask and gateway. | ON |

6.6.3 Bluetooth

This option is used to set the printer Bluetooth settings.

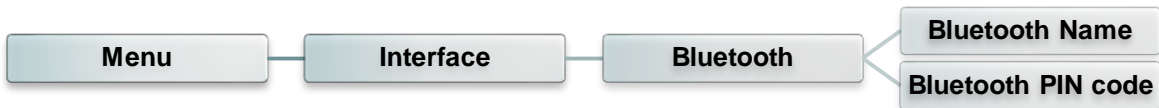

| Item | Description | Default |
|---------------------------|--|---------------|
| Bluetooth Name | This item is used to set the local name for Bluetooth. | BT-SPP |
| Bluetooth PIN Code | This item is used to set the local PIN code for Bluetooth. | 0000 |

6.6.4 Wi-Fi

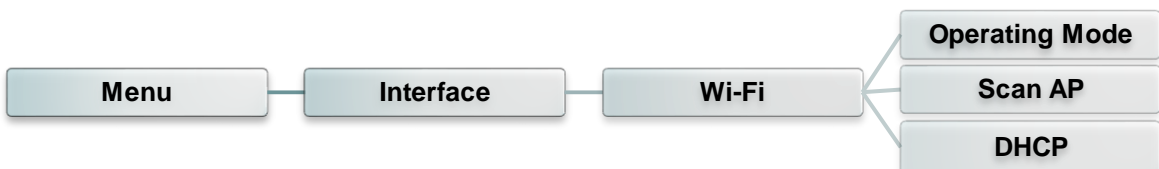

| Item | Description | Default |
|------------------|--|-----------------------|
| Operating | This item is used to set the operating mode of wireless local area networks to connect devices to the networks. Note: Infrastructure mode requires the use of an access point for this communication to take place. Ad hoc mode involves connecting a computer directly to another computer. | Infrastructure |
| Scan AP | This item is used to scan the access point device | N/A |
| DHCP | This item is used to ON or OFF the DHCP (Dynamic Host Configuration Protocol) network protocol. | ON |

6.7 File Manager

This feature is used to check the printer available memory and file list.

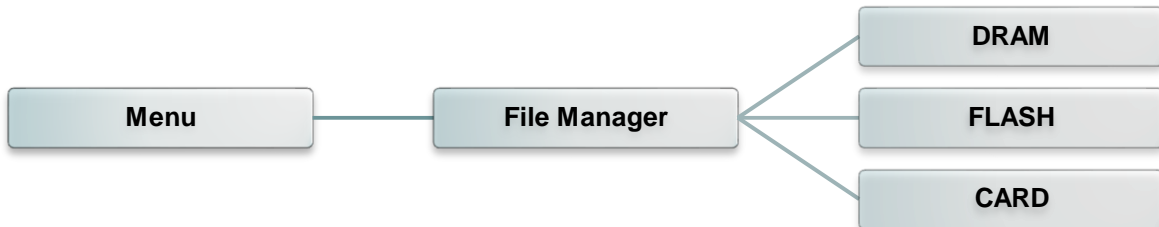

| Item | Description |
|--------------|---|
| DRAM | Use this menu to show, delete and run (.BAS) the files saved in the printer DRAM memory. |
| FLASH | Use this menu to show, delete and run (.BAS) the files saved in the printer Flash memory. |
| CARD | Use this menu to show, delete and run (.BAS) the files saved in the printer Card memory. |

6.8 Diagnostics

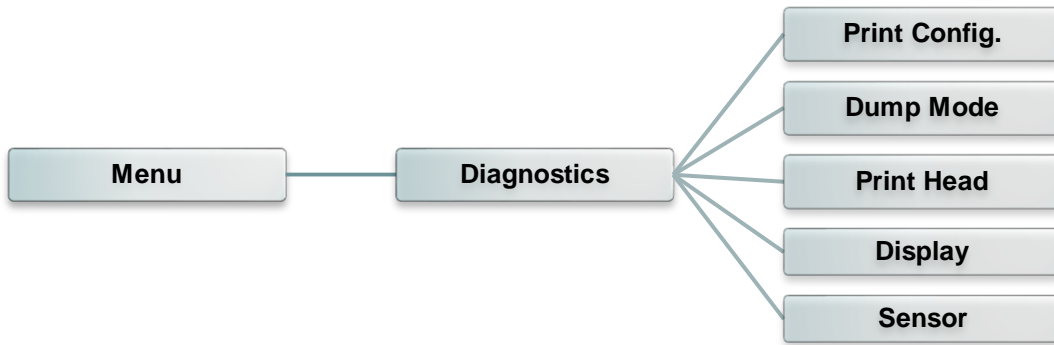

6.8.1 Print Config.

This feature is used to print current printer configuration to the label. On the configuration printout, there is a print head test pattern, which is useful for checking if there is any dot damage on the print head heater element.



| Self-test printout | |
|--------------------------------------|-------------------------|
| ----- SYSTEM INFORMATION ----- | |
| MODEL : XXXXXX | Model name |
| FIRMWARE : X.XX | F/W version |
| CHECKSUM : XXXXXXXX | Firmware checksum |
| S/N : XXXXXXXXXXXX | Printer S/N |
| TCF : NO | TSC configuration file |
| DATE : 1970/01/01 | System date |
| TIME : 00:04:18 | System time |
| NON-RESET : 110 m (TPH) | Printed mileage (meter) |
| RESET : 110 m (TPH) | Cutting counter |
| NON-RESET : 0 (CUT) | |
| RESET : 0 (CUT) | |
| ----- | |
| PRINTING SETTING ----- | |
| SPEED : 5 IPS | Print speed (inch/sec) |
| DENSITY : 8.0 | Print darkness |
| WIDTH : 4.00 INCH | Label size (inch) |
| HEIGHT : 4.00 INCH | Gap distance (inch) |
| GAP : 0.00 INCH | Gap/black mark sensor |
| INTENSION : 5 | intension |
| CODEPAGE : 850 | Code page |
| COUNTRY : 001 | Country code |
| ----- | |

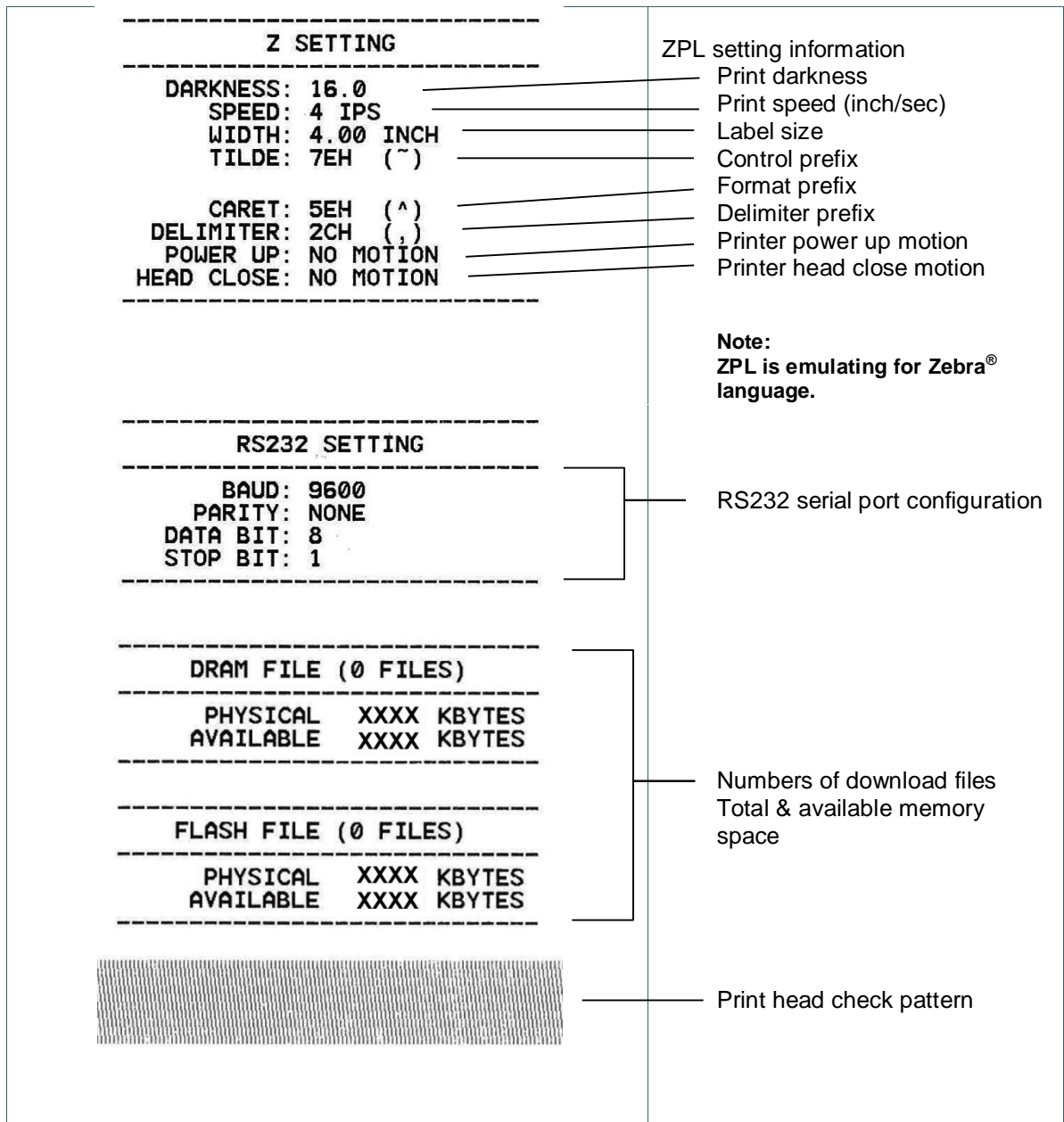

Note:
Checking dot damage requires 4" wide paper width.

6.8.2 Dump Mode

Captures the data from the communications port and prints out the data received by printer. In the dump mode, all characters will be printed in 2 columns. The left side characters are received from your system and right side data are the corresponding hexadecimal value of the characters. It allows users or engineers to verify and debug the program.

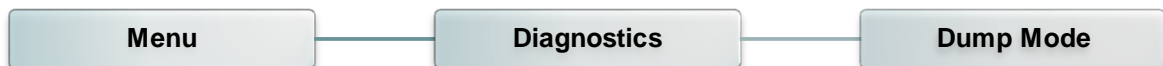

| | |
|-----------|----------------------------|
| DOWNLOA | 0D 0A 44 4F 57 4E 4C 4F 4I |
| D „TEST2. | 44 20 22 54 45 53 54 32 2E |
| DAT“,5,CL | 44 41 54 22 2C 35 2C 43 4C |
| S DOWNLO | 53 0D 0A 44 4F 57 4E 4C 4F |
| AD F,“TES | 41 44 20 46 2C 22 54 45 53 |
| T4.DAT“,5 | 54 34 2E 44 41 54 22 2C 35 |
| ,CLS DOW | 2C 43 4C 53 0D 0A 44 4F 57 |
| NLOAD „TE | 4E 4C 4F 41 44 20 22 54 45 |
| ST2.DAT“, | 53 54 32 2E 44 41 54 22 2C |
| 5,CLS DO | 35 2C 43 4C 53 0D 0A 44 4F |
| WNLOAD F, | 57 4E 4C 4F 41 44 20 46 2C |
| „TEST4.DA | 22 54 45 53 54 34 2E 44 41 |
| T“,5,CLS | 54 22 2C 35 2C 43 4C 53 0D |
| DOWNLOAD | 0A 44 4F 57 4E 4C 4F 41 44 |
| “TEST2.D | 20 22 54 45 53 54 32 2E 44 |
| AT“,5,CLS | 41 54 22 2C 35 2C 43 4C 53 |
| DOWNLOA | 0D 0A 44 4F 57 4E 4C 4F 4I |
| D F,“TEST | 44 20 46 2C 22 54 45 53 54 |
| 4.DAT“,5, | 34 2E 44 41 54 22 2C 35 2C |
| CLS | 43 4C 53 0D 0A |

ASCII Data (indicated by a red arrow pointing to the left column)

Hexadecimal data related to left column of ASCII data (indicated by a red arrow pointing to the right column)

Note:
Dump mode requires 4" wide paper width.

6.8.3 Print Head

This feature is used to check print head's temperature, resistance and bad dots.



6.8.4 Display

This feature is used to check LCD's color state.



6.8.5 Sensor

This feature is used to check media sensor state. It can increase or decrease the intensity to check the reading value for diagnostic.

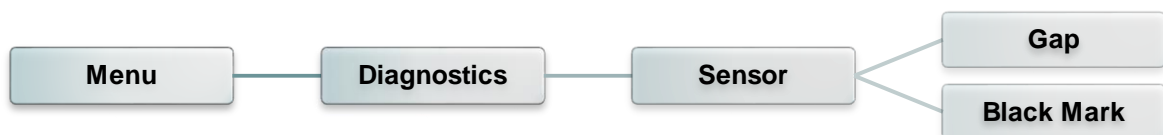

6.9 Advanced

This feature is used to set the printer LCD settings.



| Item | Description |
|---------------------------|--|
| Display Brightness | This item is used to setup the brightness for display. |
| Date & Time | This item is used to setup the date and time on display. |
| Language | This item is used to setup the language on display. |

6.10 Service

This feature is used to restore printer settings to defaults and checking information for printer.

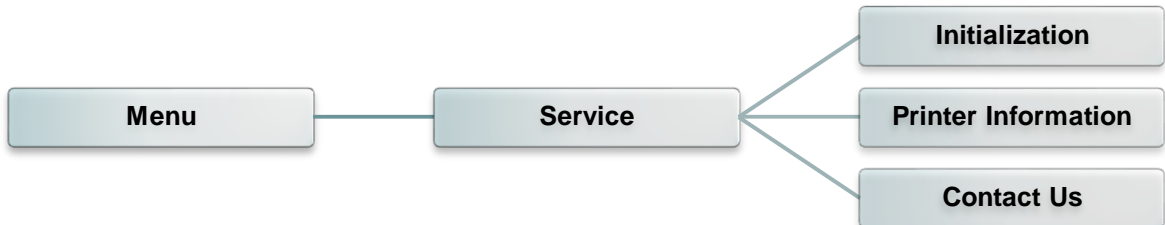

| Item | Description |
|----------------------------|--|
| Initialization | This feature is used to restore printer settings to defaults. |
| Printer Information | This feature is used to check the printer's serial number, printed mileage (m), printed labels (pcs.) and cutting counter. |
| Contact Us | This feature is used to check the contact information for tech support service. |

7. Troubleshooting

The following guide lists the most common problems that may be encountered when operating this bar code printer. If the printer still does not function after all suggested solutions have been invoked, please contact the tech support service of your purchased reseller or distributor for assistance.

| Problem | Possible Cause | Recovery Procedure |
|--|---|---|
| Power indicator does not illuminate | * The power cord is not properly connected. | * Plug the power cord in printer and outlet. * Switch the printer on. |
| - The printer status from DiagTool shows " Head Open ". - The LCD shows " Carriage Open ". | * The printer head is open. | * Please close the print carriages. |
| - The printer status from DiagTool shows " Ribbon Encoder Err. " - The LCD shows " No Ribbon ". | * Running out of ribbon. * The ribbon is installed incorrectly. | * Supply a new ribbon roll. * Please refer to the steps on section 3.3 to re-install the ribbon. |
| - The printer status from DiagTool shows " Out of Paper ". - The LCD shows " No Paper ". | * Running out of label. * The label is installed incorrectly. * Gap/black mark sensor is not calibrated. | * Supply a new label roll. * Please refer to the steps on section 3.4 to reinstall the label roll. * Calibrate the gap/black mark sensor. |
| - The printer status from DiagTool shows " Paper Jam ". - The LCD shows " Paper Jam ". | * Gap/black mark sensor is not set properly. * Make sure label size is set properly. * Labels may be stuck inside the printer mechanism. | * Calibrate the media sensor. * Set media size correctly. * Remove the stuck label inside the printer mechanism. |
| - The LCD shows " Take Label ". | * Peel-off function is enabled. | * If the peel-off module is installed, please remove the label. * If there is no peel-off module in front of the printer, please switch off the printer and install it. * Check if the connector is plugging correctly. |
| Not Printing | * Check if interface cable is well connected to the interface connector. * Check if wireless or Bluetooth device is well connected between host and printer. * The port specified in the Windows driver is not correct. | * Re-connect cable to interface or change a new cable. * If using serial cable, - Please replace the cable with pin to pin connected. - Check the baud rate setting. The default baud rate setting of printer is 9600,n,8,1. * If using the Ethernet cable, |

| | | |
|---|--|--|
| | | <ul style="list-style-type: none"> - Check if the Ethernet RJ-45 connector green LED is lit on. - Check if the Ethernet RJ-45 connector amber LED is blinking. - Check if the printer gets the IP address when using DHCP mode. - Check if the IP address is correct when using the static IP address. - Wait a few seconds let the printer get the communication with the server then check the IP address setting again. * Please reset the wireless device setting. * Select the correct printer port in the driver. * Print head's harness connector is not well connected with printhead. Turn off the printer and plug the connector again. * Check your program if there is a command PRINT at the end of the file and there must have CRLF at the end of each command line. |
| No print on the label | <ul style="list-style-type: none"> * Label or ribbon is loaded not correctly. * Use wrong type paper or ribbon | <ul style="list-style-type: none"> * Follow the instructions in loading the media and ribbon. * Ribbon and media are not compatible. * Verify the ribbon-inked side. * The print density setting is incorrect. * Clean the print head. |
| Poor Print Quality | <ul style="list-style-type: none"> * Ribbon and media is loaded incorrectly * Dust or adhesive accumulation on the print head. * Print density is not set properly. * Print head element is damaged. * Ribbon and media are incompatible. * The print head pressure is not set properly. | <ul style="list-style-type: none"> * Reload the supply. * Clean the print head. * Clean the platen roller. * Adjust the print density and print speed. * Run printer self-test and check the print head test pattern if there is dot missing in the pattern. * Change proper ribbon or proper label media. * The release lever does not latch the print head properly. |
| Cutter is not working | <ul style="list-style-type: none"> * The connector is loose. * Cutter jam. * Cutter PCB is damaged. | <ul style="list-style-type: none"> * Plug in the connect cable correctly. * Remove the label. * Make sure the thickness of label is less than 0.19 mm. * Replace a cutter driver IC board. |
| Can't downloading the file to memory (FLASH / DRAM/CARD) | <ul style="list-style-type: none"> * The space of memory is full. | <ul style="list-style-type: none"> * Delete unused files in the memory. |
| SD card is unable to use | <ul style="list-style-type: none"> * SD card is damaged. * SD card doesn't insert correctly. | <ul style="list-style-type: none"> * Use the supported capacity SD card. Please refer to section 2.2.1 * Insert the SD card again. |
| Missing printing on the left or right side of label | <ul style="list-style-type: none"> * Wrong label size setup. | <ul style="list-style-type: none"> * Set the correct label size. |
| Gray line on the blank label | <ul style="list-style-type: none"> * The print head is dirty. * The platen roller is dirty. | <ul style="list-style-type: none"> * Clean the print head. * Clean the platen roller. |

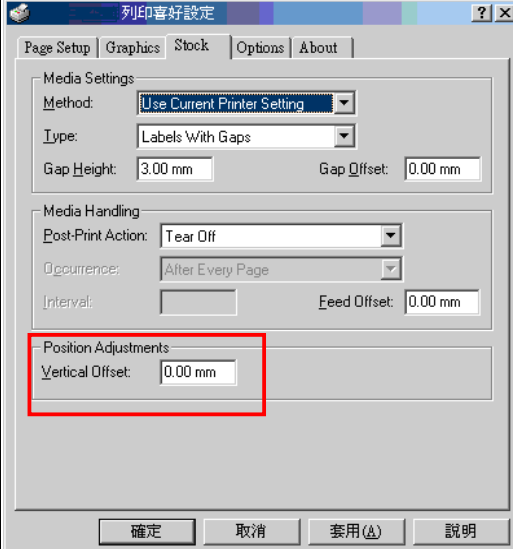
| | | |
|---|---|---|
| <p>Irregular printing</p> | <ul style="list-style-type: none"> * The printer is in Hex Dump mode. * The RS-232 setting is incorrect. | <ul style="list-style-type: none"> * Turn off and on the printer to skip the dump mode. * Re-set the Rs-232 setting. |
| <p>Label feeding is not stable (skew) when printing</p> | <ul style="list-style-type: none"> * The media guides do not touch the edge of the media. | <ul style="list-style-type: none"> * If the label is moving to the right side, please move the label guide to left. * If the label is moving to the left side, please move the label guide to right. |
| <p>Skip labels when printing</p> | <ul style="list-style-type: none"> * Label size is not specified properly. * Sensor sensitivity is not set properly. * The media sensor is covered with dust. | <ul style="list-style-type: none"> * Check if label size is setup correctly. * Calibrate the sensor by Auto Gap or Manual Gap options. * Clear the GAP/Black mark sensor by blower. |
| <p>Wrinkle Problem</p> | <ul style="list-style-type: none"> * Printhead pressure is incorrect. * Ribbon installation is incorrect. * Media installation is incorrect. * Print density is incorrect. * Media feeding is incorrect. | <ul style="list-style-type: none"> * Please set the suitable density to have good print quality. * Make sure the label guides touch the edge of the media guide. |
| <p>RTC time is incorrect when reboot the printer</p> | <ul style="list-style-type: none"> * The battery has run down. | <ul style="list-style-type: none"> * Check if there is a battery on the main board. |
| <p>The printing position of small label is incorrect</p> | <ul style="list-style-type: none"> * Media sensor sensitivity is not set properly. * Label size is incorrect. * The parameter Shift Y is incorrect. * The vertical offset setting in the driver is incorrect. | <ul style="list-style-type: none"> * Calibrate the sensor sensitivity again. * Set the correct label size and gap size. * Use DiagTool to fine tune the parameter of Shift Y. * If using the software BarTender, please set the vertical offset in the driver.  |

8. Maintenance

This session presents the clean tools and methods to maintain your printer.

1. Please use one of following material to clean the printer.

- Cotton swab
- Lint-free cloth
- Vacuum / Blower brush
- 100% Ethanol or Isopropyl Alcohol

2. The cleaning process is described as following,

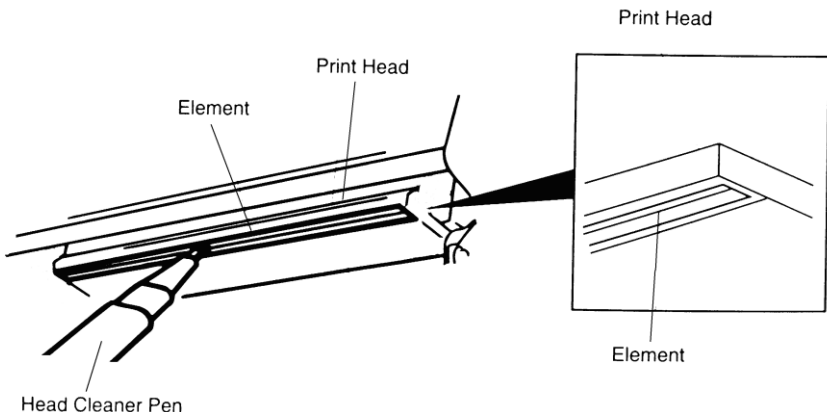
| Printer Part | Method | Interval |
|----------------------|---|---|
| Print Head | <ol style="list-style-type: none"> 1. Always turn off the printer before cleaning the print head. 2. Allow the print head to cool for a minimum of one minute. 3. Use a cotton swab and 100% Ethanol or Isopropyl Alcohol to clean the print head surface. | <p>Clean the print head when changing a new label roll.</p>  |
| Platen Roller | <ol style="list-style-type: none"> 1. Turn the power off. 2. Rotate the platen roller and wipe it thoroughly with water. | Clean the platen roller when changing a new label roll |
| Peel Bar | Use the lint-free cloth with 100% ethanol to wipe it. | As needed |
| Sensor | Compressed air or vacuum | Monthly |
| Exterior | Wipe it with water-dampened cloth | As needed |
| Interior | Brush or vacuum | As needed |

Note:

- Do not touch printer head by hand. If you touch it careless, please use ethanol to clean it.
- Please use 100% Ethenol or Isopropyl Alcohol. DO NOT use medical alcohol, which may damage the printer head.
- Regularly clean the print head and supply sensors once change a new media to keep printer performance and extend printer life.

- Continuous printing will cause printer motor overheat. Printer will stop printing automatically about 10~15 minutes until motor is cooling down. Please don't turn off power when printer pauses or the data transferred to printer buffer will be lost.
- The maximum printing ratio per dot line is 15% for this printer. To print the full web black line, the maximum black line height is limited to 40 dots, which is 5mm for 203 DPI resolution printer and 3.3mm for 300 DPI resolution printer only, otherwise this may damage the power supply.

Revise History

| Date | Content | Editor |
|------------|--|---------|
| 2015/10/21 | Modify section 2.2.1 (Recommended SD card specification) | Camille |
| 2015/12/24 | Add section 6.8.5 | Camille |
| 2017/6/8 | Modify Agency Compliance and Approvals | Kate |
| 2019/1/31 | Modify section 6.1 (LCD Menu icon) | Kate |
| 2019/4/24 | Modify section 1.2.2 (Regular cutter (full cut guillotine cutter) specification) | Kate |
| 2019/10/4 | Modify CCC certification logo | Kate |
| 2019/11/1 | Add section 3.4.2 Loading the Fan-fold Media | Kate |
| | | |
| | | |
| | | |



TSC Auto ID Technology Co., Ltd.

Corporate Headquarters

9F., No.95, Minquan Rd., Xindian Dist.,
New Taipei City 23141, Taiwan (R.O.C.)

TEL: +886-2-2218-6789

FAX: +886-2-2218-5678

Web site: www.tscprinters.com

E-mail: apac_sales@tscprinters.com

tech_support@tscprinters.com

Li Ze Plant

No.35, Sec. 2, Ligong 1st Rd., Wujie Township,
Yilan County 26841, Taiwan (R.O.C.)

TEL: +886-3-990-6677

FAX: +886-3-990-5577